

# PCAN-Diag FD

Mobile Diagnostic Device  
for CAN and CAN FD Buses

## User Manual



Document version 1.3.0 (2021-09-02)

**PEAK**  
System

## Relevant Products

Product designation	Model	Part number
PCAN-Diag FD	from firmware version 1.4.0	IPEH-003069
Charging station		IPEH-003068

Essential changes in this document resulting from changes in the firmware are listed in Appendix D on page 102.

PCAN® is a registered trademark of PEAK-System Technik GmbH. CANopen®, CANopen FD®, and CiA® are registered EU trademarks of CAN in Automation e.V. Other product names in this document may be the trademarks or registered trademarks of their respective companies. They are not explicitly marked by ™ or ®.

© 2021 PEAK-System Technik GmbH

Duplication (copying, printing, or other forms) and the electronic distribution of this document is only allowed with explicit permission of PEAK-System Technik GmbH. PEAK-System Technik GmbH reserves the right to change technical data without prior announcement. The general business conditions and the regulations of the license agreement apply. All rights are reserved.

PEAK-System Technik GmbH  
Otto-Roehm-Strasse 69  
64293 Darmstadt  
Germany

Phone: +49 6151 8173-20  
Fax: +49 6151 8173-29

[www.peak-system.com](http://www.peak-system.com)  
[info@peak-system.com](mailto:info@peak-system.com)

Document version 1.3.0 (2021-09-02)

Essential changes in this document are listed in Appendix D on page 102.

# Contents

<b>1</b>	<b>Introduction</b>	<b>7</b>
1.1	Properties at a Glance	8
1.2	Scope of Supply	11
<b>2</b>	<b>Controls and Connectors</b>	<b>13</b>
2.1	Push Dial and Hotkeys	13
2.2	CAN	14
2.3	Power (Voltage Supply)	15
2.4	Lock (Prevent Power-on)	16
2.5	USB (Access to Internal Memory Card)	17
2.6	HDMI (for External Screen)	18
2.7	Trigger (for External Measuring Device)	19
2.8	GND (Ground Connection)	19
<b>3</b>	<b>Device Startup</b>	<b>21</b>
3.1	Connecting the Voltage Supply	21
3.2	Powering On the Device	21
3.3	Setting Date and Time	22
3.4	Status Indication	22
<b>4</b>	<b>General Settings</b>	<b>24</b>
4.1	CAN	24
4.1.1	Silent startup	24
4.1.2	Detect CAN bit rate	25
4.1.3	CAN protocol	26
4.1.4	Allow bit rate switch	26
4.1.5	Bit rate	26
4.1.6	Internal termination	28
4.1.7	Listen-only mode	28
4.1.8	Auto-reset on BusOff	28

<b>4.2</b>	<b>Display</b>	<b>28</b>
4.2.1	Intro	28
4.2.2	Display orientation	29
4.2.3	HDMI output	29
4.2.4	Screensaver timeout	29
4.2.5	Backlight intensity	29
<b>4.3</b>	<b>Device</b>	<b>29</b>
4.3.1	D-Sub GND connection	30
4.3.2	Beeper	30
4.3.3	Shutdown time (battery)	30
4.3.4	Date & time	30
4.3.5	Reset file index	31
4.3.6	USB type (reboot req.)	31
4.3.7	USB autoconnect	31
<b>5</b>	<b>CAN Traffic</b>	<b>32</b>
<b>5.1</b>	<b>Raw CAN Messages</b>	<b>32</b>
5.1.1	Incoming CAN Messages	34
5.1.2	Transmit List	35
5.1.3	Transmit Sequences	37
<b>5.2</b>	<b>CAN Messages with Symbolic Representation</b>	<b>38</b>
5.2.1	Properties of the Symbolic Representation	38
5.2.2	Incoming CAN Messages	39
5.2.3	Outgoing CAN Messages	40
<b>5.3</b>	<b>Symbol File Management</b>	<b>42</b>
5.3.1	Creating a Symbol File with the PCAN Symbol Editor	43
5.3.2	Using Multiplexers in Symbol Files	49
5.3.3	Reducing a Symbol File's Size	55
<b>5.4</b>	<b>CAN Traffic Recording</b>	<b>56</b>
5.4.1	Settings for Tracing	56
5.4.2	Performing Recording	58
<b>5.5</b>	<b>Playing Back Recorded CAN Traffic</b>	<b>58</b>
<b>5.6</b>	<b>Using Recorded CAN Traffic on the PC</b>	<b>59</b>

<b>6</b>	<b>Measuring Functions for the CAN Bus</b>	<b>61</b>
6.1	Bus Load	61
6.1.1	Taking a Busload Screenshot	62
6.1.2	Settings for Busload Measurement	62
6.2	CAN Bus Termination	63
6.3	Voltages on the D-Sub Connector	66
<b>7</b>	<b>Oscilloscope Function (Scope)</b>	<b>68</b>
7.1	Properties of the Oscilloscope Function	68
7.2	Elements of the Oscilloscope Screen	69
7.3	Adjusting the View	71
7.4	Measuring a Time Period	71
7.5	Customize the view	72
7.6	Sampling Signals	73
7.6.1	Decoding of the Signal Course	73
7.6.2	Fixing Decoding Problems	74
7.7	Showing a Report about the Decoded CAN Frame	74
7.8	Saving the Scope Screen and the Sample Buffer Contents	76
7.9	Settings for the Oscilloscope Function	77
7.9.1	Trigger	77
7.9.2	CAN ID	77
7.9.3	Sample buffer size	78
7.9.4	Pretrigger size	78
7.9.5	Display trigger position	78
7.9.6	Hotkeys	78
7.9.7	View	79
7.9.8	Export	80
<b>8</b>	<b>Configuring the Device with Projects</b>	<b>81</b>
8.1	Creating and Loading a Project	83
8.2	Integrating an Alternative Splash Screen	86

<b>9</b>	<b>Maintenance Functions for the Device</b>	<b>87</b>
9.1	Updating the Firmware	87
9.2	Starting the Bootloader	89
9.3	Restoring the Factory Defaults	89
9.4	Displaying Information on Hardware and Software	89
9.5	Browsing File Directories	89
9.6	Displaying Battery Status and Resetting Monitoring	90
9.7	Calibrating the Termination Measurement	91
9.8	Managing Add-ins	91
<b>10</b>	<b>Viewing Files</b>	<b>92</b>
<b>11</b>	<b>USB Connection</b>	<b>93</b>
11.1	Automatic USB Connection	93
11.2	Manual USB Connection	94
11.3	Purposes of the USB Connection	94
11.4	Update of the Provided Tools for Windows	94
<b>12</b>	<b>Technical Specifications</b>	<b>96</b>
<b>Appendix A</b>	<b>CE Certificate</b>	<b>99</b>
<b>Appendix B</b>	<b>Dimension Drawing</b>	<b>100</b>
<b>Appendix C</b>	<b>Disposal Information (Batteries)</b>	<b>101</b>
<b>Appendix D</b>	<b>Changelog User Manual</b>	<b>102</b>

# 1 Introduction

The PCAN-Diag FD is a handheld device for diagnosis of the communication on a CAN bus. Possibilities for diagnosis are available on the protocol layer by handling CAN 2.0 and CAN FD messages as well as on the physical layer by using the oscilloscope function and further measuring functions for voltage and resistance.

The oscilloscope function is used for a qualitative assessment of the signal course on the CAN bus. Two independent measuring channels sample both lines CAN-High and CAN-Low with up to 100 MHz. Based on the signal course, the PCAN-Diag FD decodes CAN frames and shows their elements in the scope graphics.

On the protocol layer, the incoming CAN traffic is shown in a list, optionally with symbolic representation for better interpretability. For future analysis, a tracer is implemented that records the CAN traffic. On the outgoing direction, single CAN messages or even full sequences of CAN messages can be transmitted on the connected CAN bus, e.g. in order to request diagnostic data.

Recorded CAN traces can also be played back. All functions on the protocol layer are available for CAN 2.0 as well as CAN FD.

The new CAN FD standard (CAN with Flexible Data rate) is primarily characterized by higher bandwidth for data transfer. The maximum of 64 data bytes per CAN FD frame (instead of 8 so far) can be transmitted with bit rates up to 12 Mbit/s. CAN FD is downward-compatible to the CAN 2.0 A/B standard, thus CAN FD nodes can be used in existing CAN networks. However, in this case the CAN FD extensions are not applicable.

The PCAN-Diag FD is operated in a simple manner with a push dial and four function keys. The device is supplied either externally or by the internal batteries that are automatically charged during external

supply. With the optional charging station, the charging process can be accelerated.

 **Note:** This manual refers to devices that are operated with firmware version 1.4.

## 1.1 Properties at a Glance

### Hardware Features

- └ High-speed CAN channel (ISO 11898-2)
  - Complies with CAN specifications 2.0 A/B and FD
  - CAN FD support for ISO and Non-ISO standards
  - CAN FD bit rates for the data field (max. 64 bytes) from 20 kbit/s up to 12 Mbit/s
  - CAN bit rates from 20 kbit/s up to 1 Mbit/s
  - Microchip CAN transceiver MCP2558FD
- └ CAN bus connection via D-Sub, 9-pin (in accordance with CiA® 303-1)
- └ Display with 800 x 480 pixel resolution
- └ Portrait or landscape presentation depending on the function and device orientation
- └ Presentation on external display via a micro HDMI socket (DVI signal with 800 x 600 pixels)
- └ Power supply via the internal rechargeable batteries or the provided supply unit (low-voltage socket on unit)
- └ Charging of the batteries is carried out with external supply, even during operation



- └ Internal memory card for saving projects; can also be used as a mass storage device during a USB connection to a PC
- └ Device operation via a push dial and 4 buttons
- └ Operating temperature range from 0 to 50 °C (32 to 122 °F)

## Software Functions

- └ Analysis of CAN and CAN FD networks at the physical and the protocol level
- └ Selection of the bit rate from a preset list or from multiple user-defined values
- └ Automatic bit rate detection based on a bit rate list
- └ Switchable listen-only mode
- └ Switchable silent startup function (listen-only mode at wrong bit rate)
- └ Symbolic representation of incoming CAN messages using symbol files, taking into account enums (lists of values), multiplexers, and ID ranges
- └ Symbol files can be set up using the Windows software PCAN Symbol Editor supplied with this product
- └ Recording of incoming CAN messages to the internal memory card, if required, with CAN ID filtering
- └ Playback of trace files
- └ Conversion of trace data to various output formats using the Windows software PEAK-Converter supplied with this product
- └ Transmitting individual CAN frames or CAN frame sequences
- └ Decimal, hexadecimal, or binary entering of CAN data; data change of a single transmission message during runtime
- └ Transmission of CAN messages with readable ID and data by support of symbol files

- └ Measurement of CAN bus load, displayed by means of a time diagram, switchable display of error frames
- └ A bus load time diagram can be saved as bitmap
- └ Measurement of the termination of the High-speed CAN bus, even while the system is running
- └ Switchable CAN termination for the connected bus
- └ Voltage measurement at the CAN connector (D-Sub) for pins 6 and 9
- └ Management of the device configuration, transmit lists, symbol files, and all recorded data (screenshots, traces, and CSV files) in projects
- └ Optional auto-reset on Bus Off

## Oscilloscope Function

- └ Two independent measurement channels, each with a maximum sample rate of 100 MHz
- └ Display of the CAN-High and the CAN-Low signal as well as the difference of both signals
- └ Trigger configuration to various properties of CAN messages:
  - Start and end of a frame
  - CAN errors
  - CAN ID of individual frame
  - Bit Rate Switch of CAN FD frames
- └ External measurement devices can be triggered using the banana jack, 4 mm
- └ Depiction of raw CAN and CAN FD frames
- └ Decoding of CAN and CAN FD frames from the recorded signal course

- └ Display of various properties and of measuring data of the decoded CAN frame using the Report function
- └ Current view can be saved as bitmap screenshot
- └ Memory depth can be set to up to 1 Megasamples
- └ Saving sample data as CSV file
- └ Extensive zoom functions
- └ Time measurement with a resolution of up to 10 ns

### **PCAN-Diag FD Editor for windows**

- └ Convenient configuration of all available settings
- └ Compilation of transmit lists and sequences
- └ Configuration of multiple bit rates per project
- └ Device configuration, transmit lists, transmit sequences, and symbol files can be saved in projects
- └ Projects can be transferred to the internal memory card of the PCAN-Diag FD using a USB connection

## **1.2 Scope of Supply**

- └ PCAN-Diag FD with or without charging station
- └ Delivered in shockproof plastic box
- └ Configuration software PCAN-Diag FD Editor for Windows
- └ PCAN Symbol Editor for Windows
- └ Conversion software PEAK-Converter for Windows
- └ USB connection cable
- └ AC adapter with changeable plugs for Euro, U.S., and UK
- └ Connection cable from micro HDMI to DVI

- └ Manual in PDF format
- └ Printed quick start guide

## 2 Controls and Connectors

### 2.1 Push Dial and Hotkeys

Operating the PCAN-Diag FD is done by the push dial and the four hotkeys.

**Rotate:**  
Move selection frame;  
change function value.

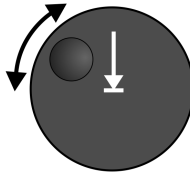

**Press:**  
Switch on device;  
execute selected  
function; execute  
additional functions by  
pressing longer.

The function of the hotkeys varies and is indicated on the display in four fields beside the control panel.



Assignment of the displayed functions to the hotkeys

Depending on the currently used function of the PCAN-Diag FD, additional functions can be executed by pressing and holding the buttons.

Press duration:

- └ Short (less than 0.2 sec.): standard function
- └ Long (approx. 1 sec.): additional function A
- └ Hold (1.5 sec.): additional function B

## 2.2 CAN



CAN connector (D-Sub) on the rear of the device

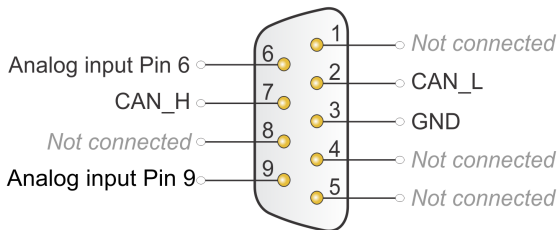

Pin assignment D-Sub, CAN pins according to specification CiA® 303-1, analog input pin 6 switchable to ground (GND)

The analog inputs can be used for general voltage measurements in the range of -28 to +28 Volts. The voltage measurement is described in section 6.3 on page 66.

## 2.3 Power (Voltage Supply)

The PCAN-Diag FD can be supplied in three ways:

- with the AC adapter via the Power socket on the rear of the device
- while the device is positioned in the charging station (AC adapter connected to the charging station)
- temporarily with the integrated batteries

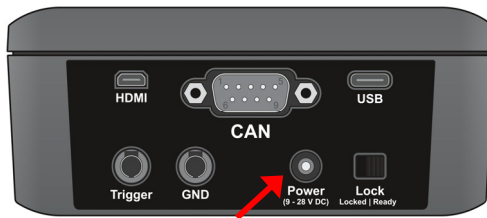

**Power socket on the rear of the device**

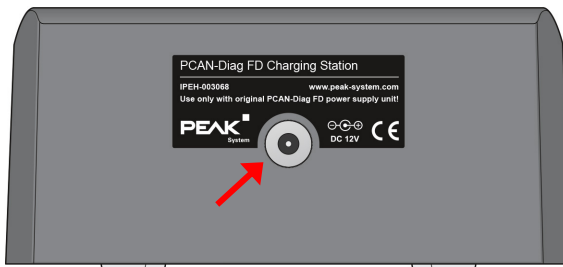

**Supply socket on the rear of the charging station (12 V DC only)**





Supply voltage:  
12 V DC (9 - 28 V possible at the Power  
socket of the PCAN-Diag FD)



Diameter of barrel connector:  
a = 5.5 mm, b = 2.1 mm;  
minimum length: 11 mm

While operation, supply status is shown on the screen's upper status bar.

Icon	Meaning
	External power supply (AC adapter) connected Blinking bars: integrated batteries are charged
	Supply by integrated batteries Indication of charge level (here about 60 %)

Approximate charging times of the batteries:

- └ Charging station: about 2 h
- └ Power socket (no operation): about 4 h
- └ Power socket (with operation): about 11 h



**Note:** The supply of the PCAN-Diag FD or the charging of the integrated batteries is not possible via a USB connection.

## 2.4 Lock (Prevent Power-on)

Powering on the device can be blocked by the Lock switch on the rear in order to prevent the batteries from accidental discharging, e.g. during transport.



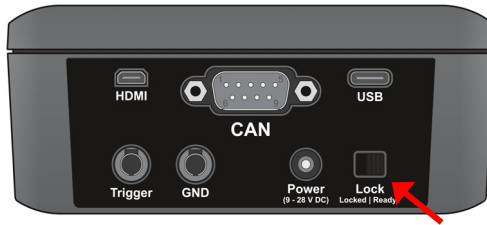

Lock switch for power-on lock on the rear of the device

▶ Do the following to activate the power-on lock:

If the device is **on**:

In the main menu, select **Power Off with Lock Switch** and afterwards push the Lock switch on the rear of the device to the **Locked** position.

If the device is **off**:

Push the Lock switch on the rear of the device to the **Locked** position.

The device now cannot be powered up with the push dial.

## 2.5 USB (Access to Internal Memory Card)



USB-C socket on the rear of the device

A USB connection to a PC is used for access to the internal memory card of the PCAN-Diag FD. The PC's operating system binds the

memory card into the file management, e.g. under Windows as mass storage device.

The included cable (USB-C to USB-A) can be used to establish the USB connection.

 **Note:** The memory card can be accessed only if the PCAN-Diag FD is switched on.

More information: 11 *USB Connection* on page 93

## 2.6 HDMI (for External Screen)



HDMI socket on the rear of the device

The video signal is output via the Micro HDMI socket as soon as a connection to an external display is established (DVI signal, 800 x 600 pixels, 4:3). During this time, the screen of the PCAN-Diag FD is switched off.

This option can be disabled, e.g. in order to suspend the video output without removing the DVI cable.

 **Note:** If the DVI connection is interrupted or restored when the option is on, switching between the external and the device screens will only occur while the main menu is active.

## 2.7 Trigger (for External Measuring Device)

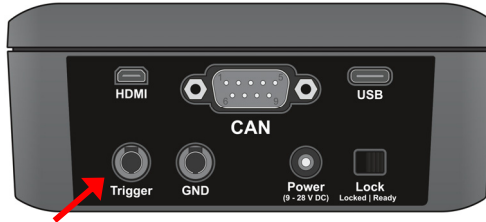

Trigger socket (4 mm) on the rear of the device

In order to trigger an external measuring device, for example a separate oscilloscope, on CAN-specific events, the trigger signal of the oscilloscope function (Scope) is available at the banana socket.

### Trigger Output

Connector	Banana jack 4 mm
Voltage idle state	0 V
Voltage trigger event	about 3 V (rising edge)
Delay to the internal trigger	none

## 2.8 GND (Ground Connection)

The D-Sub connector's shield and Pin 3 are internally connected to voltage ground (GND).

For an additional ground connection to other CAN nodes or measuring objects a **GND socket** for banana plugs (4 mm diameter, max. 2 cm length) is provided on the rear of the device.

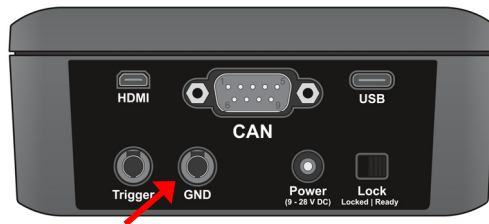

GND socket (4 mm) on the rear of the device

For testing purposes, Pin 6 can also be switched to ground  
(**Settings** > **Device Settings** > **Pin 6 GND connection**).

## 3 Device Startup

### 3.1 Connecting the voltage Supply

Connect the cable of the supplied AC adapter to the Power socket on the rear of the device.

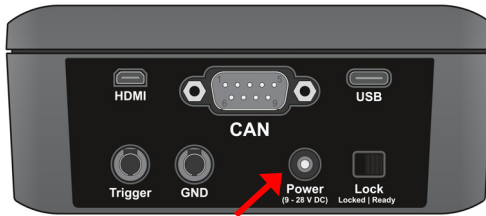

Power socket on the rear of the device

The AC adapter is suitable for mains voltages in the range of 100 to 240 V.

Plug the AC adapter into the power outlet. Depending on where you are, you must first place the appropriate plug adapter (3 different adapters supplied) onto the AC adapter.

### 3.2 Powering On the Device

Hold down the push dial for at least half a second.

A splash screen appears for a short moment; then it's replaced by the main menu.



**Tip:** If the device despite existing voltage supply (external or battery) cannot be switched on, check the power-on lock (Lock switch on the rear of the device).

To **switch off** the device, select **Power Off** from the main menu. Alternatively, you can select **Power Off with Lock Switch**, in order to activate the power-on lock directly afterwards.

### 3.3 Setting Date and Time







The PCAN-Diag FD has an integrated clock. The time stamp is used when a file is saved to the internal memory card. We recommend that you check the current date and time after the first start of the device (displayed on the upper right of the screen) and adjust them if required.

▶ Do the following to set the date and time:

1. In the main menu select **Settings**.
2. In section **Device settings**, at the entry **Date & time** click on **Set**.
3. At **Date** and at **Time**, click on the digits to be adjusted and change the values by dialing.
4. When all digits are adjusted, press the **SET** hotkey.

### 3.4 Status Indication

When operating the device, on the upper right of the screen status of the voltage supply and the CAN bus communication is indicated.

Icon	Meaning
	<p>External power supply (AC adapter) connected. Animated bars: integrated batteries are charged.</p>
	<p>Supply by integrated batteries. Indication of charge level (here about 60 %).</p>
	<p>Cell voltage out of valid range. After switching on the device, the icon may appear for a short time because the information from the internal power supply is not available immediately. If the icon appears permanently, please contact our support (contact details: on page 2). You can view the actual cell voltages under <b>Support &gt; Battery Status</b></p>
	<p>CAN traffic: T = Transmit, R = Receive Blinking: Outgoing/incoming CAN messages Green: Regular traffic Yellow, red: Errors on transmission/reception</p>
	<p>Informs about the bus status (<b>active</b>, <b>passive</b>, <b>bus off</b>). When entering bus-off state, due to high (transmit) error rate, no further CAN messages are transmitted or received. In this case, after fixing the bus problem (e.g. a wrong CAN bit rate), a reset of the CAN controller should be performed. You have the following possibilities to do so:</p> <ul style="list-style-type: none"> <li>- <b>CAN Data &gt; Raw CAN Messages &gt; Reset</b></li> <li>- <b>CAN Data &gt; Receive Msgs. as Symbols &gt; Rst</b></li> <li>- <b>Settings &gt; CAN Settings   Auto-reset on BusOff &gt; x</b> (autom.)</li> </ul>
	<p>The device operates in observation mode (listen-only). It is automatically activated if the silent startup function detects a difference between the bit rates of the device and on the bus (<b>Settings</b>). The observation mode can also be enabled or disabled manually (see section 4.1.7 on page 28).</p>

## 4 General Settings

- Main menu entry **Settings**

Here, the settings for the connection to a CAN bus and those for the use of the device are specified.

The change of these settings can be saved permanently with **Save&OK**. If the changes are to be changed only temporarily, i.e. until switching off the device, then confirm with **OK**. A subsequent session (after an off-on cycle) uses the initial settings again.



**Tip:** You can adjust the device settings quickly to different applications by means of projects (see chapter 8 on page 81).

### 4.1 CAN

This menu section contains communications settings for CAN and CAN FD connections.

#### 4.1.1 silent startup

If this function is activated, on each device start the set CAN bit rate is checked against the data traffic on the connected CAN bus. During this sequence the listen-only mode is active in order to avoid impact on the CAN traffic by the PCAN-Diag FD. This is indicated by the **L** in the top line.

If the device's bit rate matches, the listen-only mode is deactivated after a short period, else it stays active.





**Tip:** You can activate or deactivate the listen-only mode manually with the corresponding device setting **Listen-only mode**.

#### 4.1.2 Detect CAN bit rate

If the bit rate of the CAN bus connected to the PCAN-Diag FD is unknown, the PCAN-Diag FD can automatically detect it.

▶ Do the following to perform the bit rate detection:

1. Click **Detect**.

The bit rate detection screen appears.

2. Select the (**CAN protocol**) being used on the connected CAN bus.
3. Make sure that there is CAN traffic between already existing CAN nodes on the connected CAN bus.
4. Press the **START** hotkey to begin the detection process.

Depending on the set CAN protocol, a number of bit rates or bit rate sets are tried. This process can take a while.

5. If a bit rate or bit rate set has been detected, confirm the corresponding message with a click and press the **APPLY** hotkey to accept it.

The settings **CAN protocol**, **Allow bit rate switch**, and **Bit rate** have been updated with the detected bit rate or bit rate set.

6. Confirm the settings with the **OK** or the **SAVE&OK** hotkey (latter for permanent saving).

### 4.1.3 CAN protocol

Three protocols are available here: **CAN2.0B**, **FD iso**, and **FD non-iso**.



**Note:** Since the first implementation of CAN FD, the standard was refined and finally released in the specification ISO 11898-1. The revised CAN FD standard is not compatible to the original protocol (non-ISO). PEAK-System takes this into account by supporting both protocol versions in their CAN FD interfaces.

### 4.1.4 Allow bit rate switch

Allows the bit rate switch for CAN FD messages so that besides the nominal bit rate also the separate one for the data part of the CAN FD frame is used.



**Note:** This setting must correspond to that of all other CAN FD nodes on the CAN bus.

### 4.1.5 Bit rate

Via **Edit** a preset can be selected that corresponds to the bit rate on the connected CAN bus. The selection options depend on the selected CAN protocol in the higher-level Settings screen:

- └ on CAN 2.0:  
Based on the frequency selected in the **Clock** section, different lists of bit rates are available.
- └ on CAN FD (ISO and Non-ISO):  
Sets of clock frequency, nominal bit rate and data bit rate are available for selection as so-called bit rate sets.

 **Note:** When selecting a bit rate set for CAN FD, also pay attention to the additional setting (**Allow bit rate switch**) to be able to use the data bit rate if required.

If there is no suitable bit rate or bit rate set in the respective list, you can create new ones using the **NEW BR** hotkey.

 Do the following to create a new bit rate or a new bit rate set:

1. Press the **NEW BR** hotkey.
2. Use the **Type** field to determine if you want to create a bit rate set (nominal bit rate and data bit rate) or a single bit rate.

Accordingly, the settings for the nominal and the data bit rate are available below.

3. Select the **Clock** frequency to be used as basis for calculation of the bit rates.
4. Set up a bit rate with the four parameters:  
**BRP**: prescaler, yields the time quantum  $T_q$   
**TSEG1/2**: segment length (time quanta count)  
**SJW**: synchronisation jump with (time quanta count)

The resulting bit rate settings are displayed below.



**Tip:** PEAK-System offers the “Bit Rate Calculation Tool” for Android, iOS, and Windows to help you specifying the correct parameters. You can get the software for free from the following web page:

[www.peak-system.com/quick/DL-Software-E](http://www.peak-system.com/quick/DL-Software-E)

5. Finally, press the **ADD** hotkey.

### 4.1.6 Internal termination

A High-speed CAN bus needs to be electrically terminated on both ends using resistors of 120 Ohm. If the PCAN-Diag FD is connected to an unterminated end of a CAN bus, the internal terminating resistor of 124 Ohm can be engaged here.

### 4.1.7 Listen-only mode

If you want the device to not affect the traffic on the CAN bus, i.e. use it as pure monitoring tool, the Listen-only mode must be activated (**On**). The device will neither acknowledge incoming CAN frames nor will it transmit error frames. Furthermore, active transmit lists are deactivated.

### 4.1.8 Auto-reset on BusOff

If the function is activated (**On**), the PCAN-Diag FD automatically performs a reset of the CAN controller when it has changed to BusOff state due to many transmission errors. This can come in handy e.g. while doing experiments with bit rates on other CAN nodes.

## 4.2 Display

This menu section contains screen and display settings.

### 4.2.1 Intro

Determines if a splash screen is shown as the device is switched on.

### 4.2.2 Display orientation

The orientation of the screen can be determined automatically or set to the following values: 0° (portrait view), 90° (landscape view, controls on the right), 180° (portrait view, upside down), 270° (landscape view, controls on the left).

### 4.2.3 HDMI output

The video signal is output via the Micro HDMI socket as soon as a connection to an external display is established (DVI signal, 800 x 600 pixels, 4:3). During this time, the screen of the PCAN-Diag FD is switched off.

This option can be disabled, e.g. in order to suspend the video output without removing the DVI cable.



**Note:** If the DVI connection is interrupted or restored when the option is on, switching between the external and the device screens will only occur while the main menu is active.

### 4.2.4 Screensaver timeout

The brightness of the display will be reduced whenever the device is not operated for a certain period. This can prolong the operation time with batteries.

### 4.2.5 Backlight intensity

The screen brightness can be set to a value in the range of 30 to 100 percent. Default is 70 percent.

## 4.3 Device

This menu section contains device settings.

### 4.3.1 D-Sub GND connection

Pin 6 of the D-Sub connector can internally be connected to the device ground (pin 3, shield, GND socket) for testing purposes (**On**).

 **Note:** If pin 6 of the CAN cabling is used for other purposes than a ground connection, this setting must be disabled (**Off**) in order to avoid a short circuit from a powered lead to ground.

### 4.3.2 Beeper

The PCAN-Diag FD can give acoustic feedback to several events. Among other, a change of the CAN bus status is signaled. The **Off** setting disables the acoustic signal function of the PCAN-Diag FD.

### 4.3.3 Shutdown time (battery)

If the PCAN-Diag FD is run with batteries, energy can be saved by switching off the device automatically after a set period, as long as the push dial hasn't been used. Setting to **Never** causes the device to stay alive all the time.

If operating the device with an external supply, for example with the enclosed AC adapter, this setting does not have any effect.

 **Note:** In battery mode, the device remains switched on as long as a trace is being recorded. This may cause the battery to run down before the trace recording is stopped. We recommend using an external power supply for longer trace recordings.

### 4.3.4 Date & time

With **Set** the device date and time are adjusted. Date and time are used when saving files to the internal memory card.

### 4.3.5 Reset file index

File names of bitmaps or scope data to be saved get a number coming from a counter. The current count is indicated in parentheses and can be set to 0 by clicking **Reset**.

### 4.3.6 USB type (reboot req.)

The PCAN-Diag FD can operate as USB device (Device) or as USB host. A changed setting is active after a restart of the device.



**Note:** The host function is intended for special purposes and is not regularly available.

### 4.3.7 USB autoconnect

Here, an automatic (**On**) or manual (**Off**) USB connection to an operating system on a connected PC can be set. For more information, see chapter 11 on page 93.

## 5 CAN Traffic

- Main menu item **CAN Data**

The PCAN-Diag FD can display the data of incoming and outgoing CAN messages either in a plain way in hexadecimal format (section 5.1 below) or with the help of symbol files that convert the CAN data into a more readable form (sections 5.2/5.3 from on page 38).

In addition there's the possibility to record incoming CAN traffic to files on the internal memory card. The recorded data can later be played back 1:1 or, on a PC, can be converted to various output formats and evaluated (sections 5.4/5.5/5.6 from on page 56).

### 5.1 Raw CAN Messages

- Menu item **CAN Data** > **Raw CAN Messages**

Up to three areas are visible on the screen, arranged vertically:

- └ List of incoming CAN messages (with **RxID** column), always shown
- └ Transmit list (with **TxID** column), can be shown or hidden
- └ Transmit sequences (with **Tx Sequence Name** column), can be shown or hidden

▶ Do the following to show or hide the transmit areas:

1. By using the push dial move the selection frame to the menu bar and click to activate it.
2. Click on **View** until you see the view you want.  
Sequence of views: no transmit area > transmit list >



transmit list + transmit sequences > transmit sequences >  
no transmit area



**Tip:** In the **Settings** menu item, a view can be saved permanently.

### Reset

Clears the list of incoming CAN messages and resets the CAN controller. Latter is useful after fault maintenance on the CAN bus.

As long as an area is not selected (light yellow frame on area), a reset can also be executed via hotkey.

### View

Switches on or off additional areas on the screen for transmission of CAN messages on each click:

- └ Transmit list
- └ Transmit list and transmit sequences
- └ Transmit sequences

The view can be permanently set under **Settings** (see the following explanation).

### Settings

The view of the transmit areas can be configured here and be saved permanently if required.

### Transmit View

View of the transmit areas as described before.

### Current Tx List

Currently used transmit list (\* .xmt). By clicking, another transmit list can be loaded from the internal memory card.

### Save Tx List on Exit

Manual changes in the transmit list are saved **Never**, upon request (**Ask**), or **Always**.

When you have changed settings, save them permanently with the **SAVE&OK** hotkey. If you want to use the changed settings only temporarily (during the current session), press the **OK** hotkey. A subsequent session (after an off-on cycle) uses the initial settings again.

#### 5.1.1 Incoming CAN Messages

Incoming CAN messages are shown as a list, sorted by CAN RxID (column **RxID**). The representation of the CAN data bytes (**Data D...N**) is in hexadecimal format. Each occurrence of a CAN message increments its counter (**Count**). The counting starts with the invocation of the CAN message view. The **T.Diff.** column indicates the period between the last two occurrences of a CAN message (display only at portrait view).

**Red list entries** indicate CAN errors that are reported by the CAN controller.

▶ Do the following to **change the sorting and view** in the receive list:

1. By turning, place the selection frame onto the receive list.
2. To move a single message or to change its representation, press the push dial and move the desired CAN message in the receive list by turning.

3. Press the **MENU** hotkey and select the desired action, depending on the selection for the whole receive list or for a single message.

### 5.1.2 Transmit List

The transmit list contains independent CAN messages with static data. The messages are transmitted cyclically or manually.

- ▶ Do the following to show the area for the transmit list (with **TxID** column) if not visible:
  1. By using the push dial move the selection frame to the menu bar and click to activate it.
  2. Click on **View** until you see the view you want.  
Sequence of views: no transmit area > transmit list > transmit list + transmit sequences > transmit sequences > no transmit area

### Transmit Possibilities

- **Manually** by selecting a CAN message and pressing the **SEND** hotkey or by clicking on the message (only if cycle time is 0).
- **Cyclically** if a cycle time greater than 0 is given. Cyclic transmission can be switched on or off by clicking on the corresponding CAN message; for all entries by pressing the **MENU** hotkey and clicking on **Start All** or **Stop All**.

### Fill Transmit List

The transmit list can either be filled from a file (\*.xmt) or manually.



**Tip:** You can create a transmit list file, for example, with the Windows program PCAN-View which is available free of charge.

▶ To open a transmit list file from the internal memory card, do the following:

1. Make sure that the transmit list (with **TxID** column) is shown (menu item **View**).
2. By turning, place the selection frame onto the transmit list.
3. Press the **MENU** hotkey and click on **Load File**.

All transmit list files (\*.xmt) in the directory of the current project are shown.

4. Click on the desired transmit list file.

The transmit list is filled with all CAN messages from the file. Previous entries are removed.

▶ To add a CAN message to the transmit list, do the following:

1. By turning, move the selection frame onto the transmit list (upper area) and click.
2. Press the **MENU** hotkey and click on **Load File**.
3. Enter the parameters for the new CAN message in the transmit list.
4. Press the **OK** hotkey.

The new CAN message appears in the transmit list.

 **Note:** Changes in the transmit list are saved according to **Settings** > **Save Tx List on Exit**.

### 5.1.3 Transmit Sequences

Transmit sequences contain several CAN messages that are transmitted in succession with defined intervals.

- ▶ Do the following to show the area for the transmit sequences (with **Tx Sequence Name** column) if not visible:
  1. By using the push dial move the selection frame to the menu bar and click to activate it.
  2. Click on **View** until you see the view you want.  
Sequence of views: no transmit area > transmit list > transmit list + transmit sequences > transmit sequences > no transmit area

### Transmit Possibilities

- └ **Once manually** by selecting a transmit sequence and pressing the **SEND 1X** hotkey.
- └ **Cyclic**; is switched on or off by clicking on a transmit sequence.

### Creating a Transmit Sequence

A transmit sequence is created with the help of the Windows program PCAN-View and afterwards taken over into a project with the PCAN-Diag FD Editor. It interprets a transmit list (\*.xmt) after changing the file name extension to \*.xms as transmit sequence.

- ▶ Do the following to create a transmit sequence:
  1. Start the Windows program PCAN-View, e.g. from the internal memory card of the PCAN-Diag FD (directory \PCAN-Diag FD\Tools\PCAN-View\).
  2. Create a list of CAN messages in the Transmit window. The Cycle Time of a CAN message later determines the delay to the following message.

3. Save the transmit list (\*.xmt) and rename the file name extension to \*.xms.
4. In the PCAN-Diag FD Editor on the **CAN Sequence Lists** page, import the previously created transmit sequence file.
5. Transfer the project with the transmit sequence to the PCAN-Diag FD and open it there (if another project is in use).

## 5.2 CAN Messages with Symbolic Representation

In order to simplify the interpretation of CAN data, it can be represented in symbolic form. For receiving and transmitting CAN messages in this form, a separate view is available in each case. The representation of the CAN messages is determined by a symbol file.



**Note:** Before you can represent CAN messages in symbolic form, you must have loaded a symbol file being part of a project. More in section 5.3 *Symbol/* File Management on page 42.

### 5.2.1 Properties of the Symbolic Representation

- A CAN ID is identified with a name by using a **symbol**.
- Bit sequences in a CAN message representing individual quantities are given a name by **variables** or **signals**.
- Data can either be represented in decimal, in hexadecimal, or in binary format. The binary representation in the PCAN-Diag FD is done with a maximum of 16 digits. If more binary digits are necessary, the value is automatically represented decimally instead of binary.

- Variables can convert raw data transmitted via CAN and represent it as physical quantity with a unit.
- Specific variable values can be represented alphanumerically by using **enums** (value lists).
- **Multiplexers** define different symbol definitions for data output of a single CAN ID.

### 5.2.2 Incoming CAN Messages

➤ Menu item **CAN Data** > **Receive Symbols**

The incoming CAN messages (symbols) are shown in a list view. Values (variables/signals) contained in the CAN messages appear in sublists.

 **Note:** Currently, receive symbol definitions without data length specification (“Valid for all data lengths”) are not supported by the PCAN-Diag FD. Respective CAN messages are highlighted in red in the list.

In addition, **transmit sequences** are available in the lower part of the screen. These do not use the symbolic representation. Toggling between the two areas is done with the **GOTO TX/GOTO RX** hotkey. More information about transmit sequences and their handling in section 5.1.3 on page 37.

The currently active **symbol file** is indicated in the lower status bar by **Name**. A different symbol file can be selected with the menu command **CAN Data** > **Manage Symbol Files**.

## Customizing the List Display

Display customization	User action	Remark
Expand or collapse a symbol	Use the push dial to <b>click</b> on a symbol or its data.	The data of the selected symbol is expanded or collapsed.
Expand or collapse all symbols	<b>Keep push dial pressed</b> (1.5 sec.).	The data of all symbols is expanded or collapsed.
Hide a symbol completely	Use <b>CAN Data &gt; Manage Symbol Files</b> .	Symbols can be permanently excluded from display there.
Sort the displayed symbols	Press <b>SORT</b> hotkey and select the element for sorting.	Changes in the list that would have influence on the sort order are not treated dynamically. To resort the list, select the sort command again.
Refill list	Press <b>RESET</b> hotkey.	In addition, the CAN controller of the PCAN-Diag FD is reset. This is useful after fault maintenance on the CAN bus.

### 5.2.3 Outgoing CAN Messages

➤ Menu item **CAN Data > Transmit Symbols**

The outgoing CAN messages (symbols) are shown in a list view. Values (variables/signals) contained in the CAN messages appear in sublists.

According to the active symbol file, an entry is displayed for each symbol definition created for transmit purposes. The currently active symbol file is indicated in the lower status bar by **Name**. A different symbol file can be selected with the menu command **CAN Data > Manage Symbol Files**.



## Transmit Possibilities

- **Manually** by clicking on a symbol (exception: symbol with cycle time).
- **Cyclically** if the symbol definition includes a cycle time. Clicking on such a message interrupts the cyclic transmission process and the entry appears red in the list. Another click resumes the transmission process.

## Changing Values

Using the **EDIT** hotkey, the cycle time is changed for symbols, for variables/signals the corresponding value is changed.

An editing window appears for this purpose. The push dial can be used to change individual digits of the value, and the **DEL** hotkey is used to delete a digit.

As soon as the **Transmit Symbols** screen is left with **EXIT**, a prompt appears asking whether the value changes should be saved. These are then available again after a restart of the device.



**Tip:** When you create a symbol file, assign default values to the individual variables/symbols already then.

## Customizing the List Display

Display customization	User action	Remark
Expand or collapse a symbol	Using the push dial, click on a symbol and <b>hold for a medium time (1 sec.)</b> .	The data of the selected symbol is expanded or collapsed.
Expand or collapse all symbols	<b>Keep push dial pressed</b> (1.5 sec.).	The data of all symbols is expanded or collapsed.

Display customization	User action	Remark
Hide a symbol completely	In advance, using the <b>PCAN-Symbol Editor</b> , assign the display mode "Off" to the symbol definition.	Symbols can be permanently excluded from display via the symbol file to be imported with the project.
Refill list	Press <b>RESET</b> hotkey.	In addition, the CAN controller of the PCAN-Diag FD is reset. This is useful after fault maintenance on the CAN bus.

## 5.3 Symbol File Management

- Menu item **CAN Data** > **Manage Symbol Files**

With a symbol file the symbolic representation of CAN messages is determined.

Using symbol files:

- └ One or more symbol files are made available in the PCAN-Diag FD by a project (more about projects in chapter 8 on page 81).
- └ For symbolic representation in the PCAN-Diag FD a single symbol file is used.
- └ Symbol files can be created and altered in different ways (only externally on a PC):
  - with the provided Windows program PCAN Symbol Editor (see the following section 5.3.1 on page 43)
  - in a text editor
  - by importing a CANdb data base (only with licensed Windows program PCAN-Explorer 6 with CANdb Add-in, both available from PEAK-System)

- └ Any symbol files (\*.sym) on a PC can be used for a project. A project is created with the windows program PCAN-Diag FD Editor (see section 8.1 on page 83).
- └ A symbol file to be used in the PCAN-Diag FD may contain a maximum number of the following elements:
  - 450 receive symbols
  - 40 variables per symbol
  - 1100 variables in all
  - 400 enums

In the PCAN-Diag FD the symbol file to be used is selected, and it is determined which elements of this symbol file are displayed.

#### SelectFile

Shows a list of symbol files that are provided by the current project. Select a symbol file that will be used for representation in **Receive Msgs. as Symbols**.

#### EditFile

Shows a preview with the current symbol file. Select the elements to be displayed in case of representing CAN messages in symbolic form. Click on an entry to alter its status. Reactivate all entries for display with **Sel.All** or vice versa with **Sel.None**.

### 5.3.1 Creating a Symbol File with the PCAN Symbol Editor

With the aid of an example, this section shows how to create a symbol file with the supplied Windows program PCAN Symbol Editor 6. The example takes the following CAN messages into account:

Symbol (data length)	CAN ID	Variable (unit)	Bits (count)	Enum
TestSymA (2 bytes)	223h	Speed (km/h)	0 - 7 (8)	
		Temperature (° C)	8 - 15 (8)	
TestSymB (1 byte)	224h	Switch1	0 (1)	Switches: 0 = Off, 1 = On



**Note:** Currently, receive symbol definitions without data length specification (“Valid for all data lengths”) are not supported by the PCAN-Diag FD. Respective CAN messages are highlighted in red in the list.

Do the following to create the symbol file:

1. Start the provided Windows program PCAN-Symbol Editor (`PcanSedt.exe`), e.g. from the internal memory card of the PCAN-Diag FD (directory `\PCAN-Diag FD\Tools\`).
2. After program start, create a new symbol file by clicking on the desired symbol format. Select the **Symbols File Format 6.0** for support of the CAN FD standard.

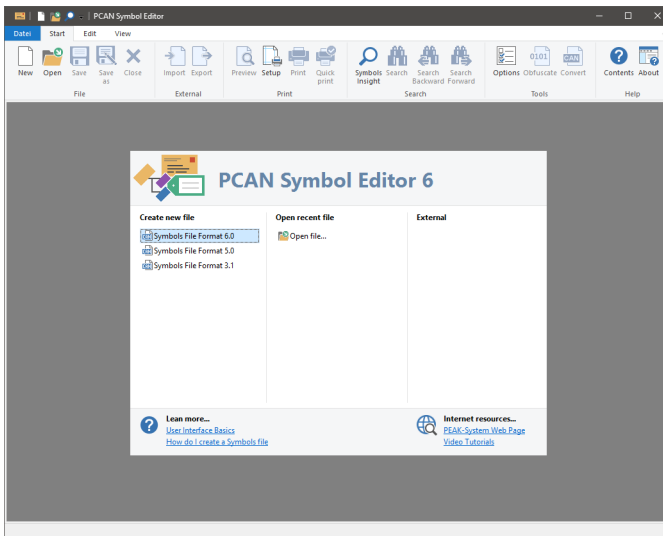

3. Afterwards, the folders in the **Item Navigator** on the left hand side are still empty. Open the **Edit** ribbon and select **Add Symbol**.

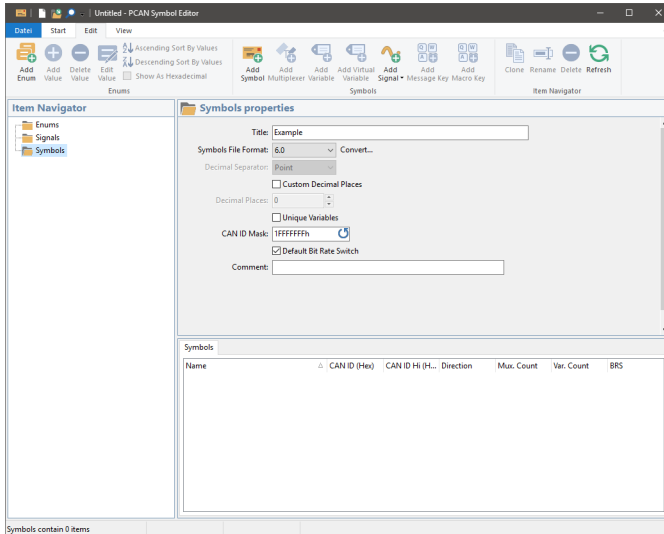

A new entry appears in the Symbols folder of the Item Navigator.

4. Adjust the items in the **Symbol properties** panel according to the given values for the TestSymA symbol.

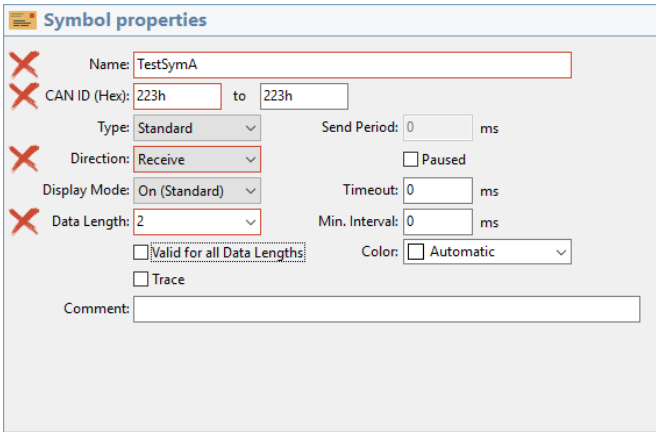

**Symbol properties**

Name: TestSymA

CAN ID (Hex): 223h to 223h

Type: Standard Send Period: 0 ms

Direction: Receive  Paused

Display Mode: On (Standard) Timeout: 0 ms

Data Length: 2 Min. Interval: 0 ms

Valid for all Data Lengths Color: Automatic

Trace

Comment:

Adjustments are done for the marked items.

5. Click on **Add Variable**. As before with the symbol, adjust the items according to the given values for the Speed variable.

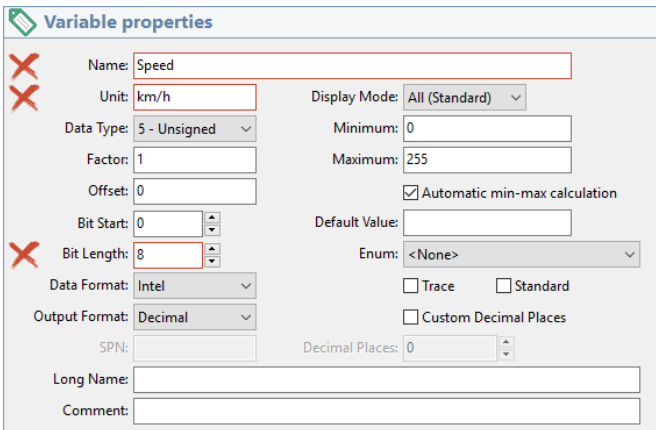

**Variable properties**

Name: Speed

Unit: km/h Display Mode: All (Standard)

Data Type: 5 - Unsigned Minimum: 0

Factor: 1 Maximum: 255

Offset: 0  Automatic min-max calculation

Bit Start: 0 Default Value:

Bit Length: 8 Enum: <None>

Data Format: Intel  Trace  Standard

Output Format: Decimal  Custom Decimal Places

SPN: Decimal Places: 0

Long Name:

Comment:

6. Repeat the previous step for the Temperature variable.

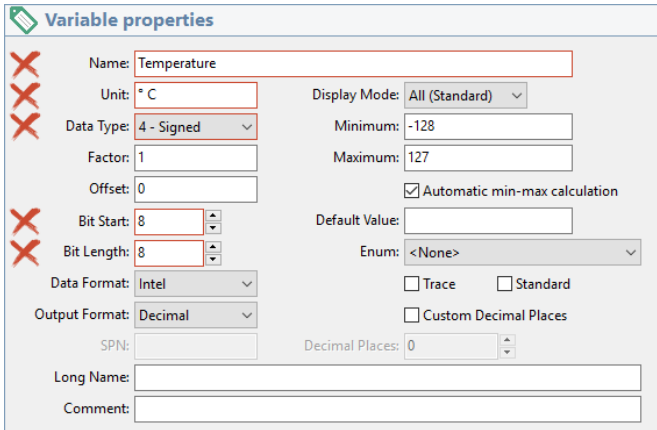
A screenshot of the "Variable properties" dialog box. The dialog has a title bar with a green icon and the text "Variable properties". The main area is divided into two columns. The left column contains fields for Name, Unit, Data Type, Factor, Offset, Bit Start, Bit Length, Data Format, Output Format, SPN, Long Name, and Comment. The right column contains fields for Display Mode, Minimum, Maximum, Automatic min-max calculation, Default Value, Enum, Trace, Standard, Custom Decimal Places, and Decimal Places. Red 'X' marks are placed to the left of the Name, Unit, Data Type, Bit Start, and Bit Length fields. The values are: Name: Temperature, Unit: ° C, Data Type: 4 - Signed, Factor: 1, Offset: 0, Bit Start: 8, Bit Length: 8, Display Mode: All (Standard), Minimum: -128, Maximum: 127, Automatic min-max calculation: checked, Default Value: (empty), Enum: <None>, Trace: unchecked, Standard: unchecked, Custom Decimal Places: unchecked, Decimal Places: 0, SPN: (empty), Long Name: (empty), Comment: (empty).

In order to display negative values  
the **Data Type** must be set to **Signed**.

7. With **Add Enum** create the Switches enum. Later on this is used for the Switch1 variable.

A new entry appears in the Enums folder of the Item Navigator.

8. Add the two states Off (0) and On (1) to the enum with **Add Value**.
9. Create the TestSymb symbol with the Switch1 variable.

**Symbol properties**

Name: TestSymB

CAN ID (Hex): 224h to 224h

Type: Standard Send Period: 0 ms

Direction: Receive  Paused

Display Mode: On (Standard) Timeout: 0 ms

Data Length: 1 Min. Interval: 0 ms

Valid for all Data Lengths Color: Automatic

Trace

Comment:

**Variable properties**

Name: Switch1

Unit:

Data Type: 1 - Bit Display Mode: All (Standard)

Factor: 1 Minimum: 0

Offset: 0 Maximum: 1

Bit Start: 0  Automatic min-max calculation

Bit Length: 1

Data Format: Intel Default Value:

Output Format: Decimal  Enum: Switches

SPN: Decimal Places: 0  Trace  Standard

Custom Decimal Places

Long Name:

Comment:

The variable uses the Switches enum.

- Use **Save as** to save the symbol file with the name `SymExample.sym`.



The final symbol file has the following contents:

```

FormatVersion=6.0 // Do not edit this line!
Title="Example"

{ENUMS}
Enum=Switches(0="Off", 1="On")

{RECEIVE}

[TestSymA]
ID=223h
Len=2
Var=Speed unsigned 0,8 /u:km/h
Var=Temperature signed 8,8 /u:"° C"

[TestSymB]
ID=224h
Len=1
Var=Switch1 bit 0.1 /e:Switches
  
```

### 5.3.2 Using Multiplexers in Symbol Files

With multiplexers different symbol definitions are used for the representation of CAN data from a single message. An area of the CAN data is defined as multiplexer. The contained value indicates the symbolic representation to be used for the rest of the data in the CAN message. With the aid of an example, this section shows how to create a symbol file with multiplexers.

Symbol (CAN ID)	Multiplexer area (bit count)	Multiplexer value	Data length	Variable (unit)	Bits (count)
MuxSym (200h)	0 (1)	00h	2 bytes	Speed (km/h)	1 - 7 (7)
				Temperature (° C)	8 - 15 (8)
	01h	2 bytes	Engine (rpm)	1 - 7 (7)	
			Temperature (° C)	8 - 15 (8)	

- ▶ Do the following to create a symbol file with multiplexers:
1. Start the provided Windows program PCAN-Symbol Editor (`PcanSedt.exe`), e.g. from the internal memory card of the PCAN-Diag FD (directory `\PCAN-Diag FD\Tools\`).
  2. After program start, create a new symbol file by clicking on the desired symbol format. Select the **Symbols File Format 6.0** for support of the CAN FD standard.

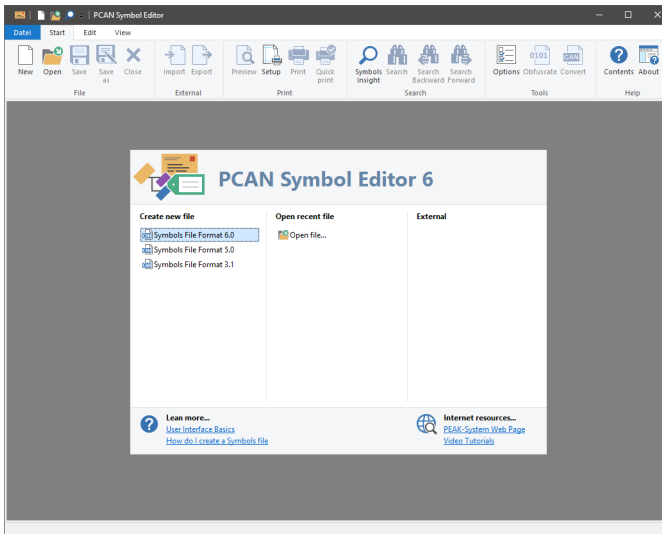

3. Change to the **Edit** ribbon and select **Add Symbol**.

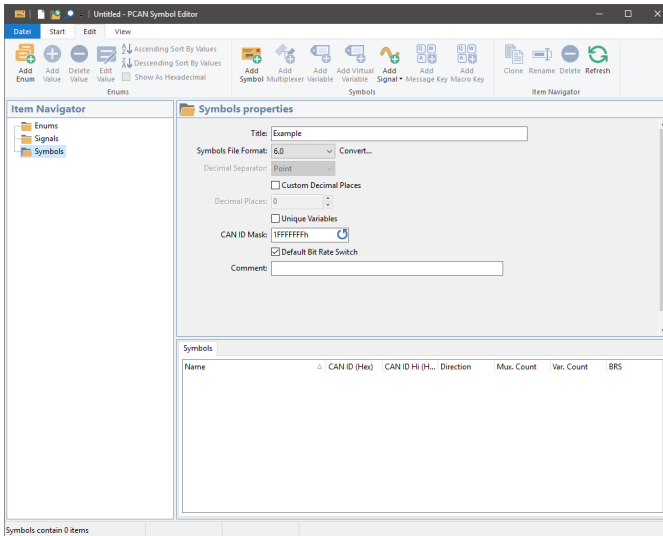

- Adjust the items in the **Symbol properties** panel according to the given values for the MuxSym symbol.

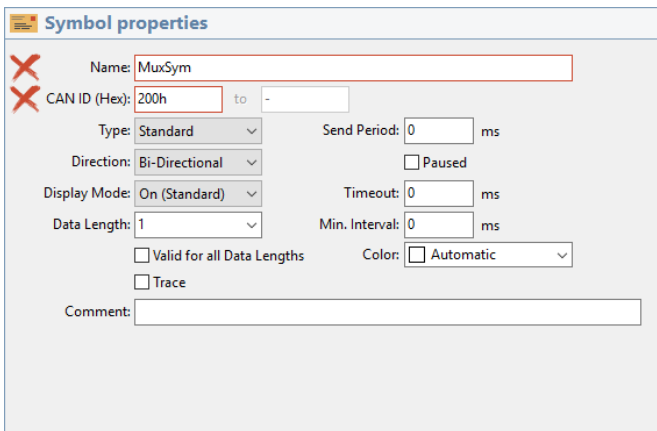

The data length is not relevant at this point.  
It is determined later separately for each multiplexer.

5. Add two multiplexers to the symbol by using **Add Multiplexer**.

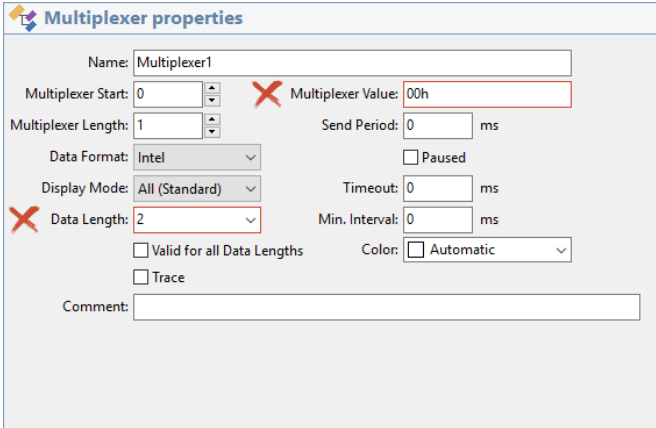

**Multiplexer properties**

Name: Multiplexer1

Multiplexer Start: 0  Multiplexer Value: 00h

Multiplexer Length: 1 Send Period: 0 ms

Data Format: Intel  Paused

Display Mode: All (Standard) Timeout: 0 ms

Data Length: 2 Min. Interval: 0 ms

Valid for all Data Lengths Color: Automatic

Trace

Comment:

Multiplexer2 gets the value 01h (field **Multiplexer Value**).

When the symbol file is used in the PCAN-Diag FD, the multiplexers are treated as a single signal named Mux. The names given in the PCAN Symbol Editor are dismissed. Therefore, for both multiplexers only the value must be indicated, for which a multiplexer comes into effect.

 **Note:** If a symbol contains a multiplexer with dynamic data length (setting **Valid for all Data Lengths**), only this single multiplexer is used for the PCAN-Diag FD. Further multiplexers in the corresponding symbol are ignored. The data length yields from the contained variables.

6. Add the Speed variable to Multiplexer1 by using **Add Variable** and adjust the entries according to the shown example.

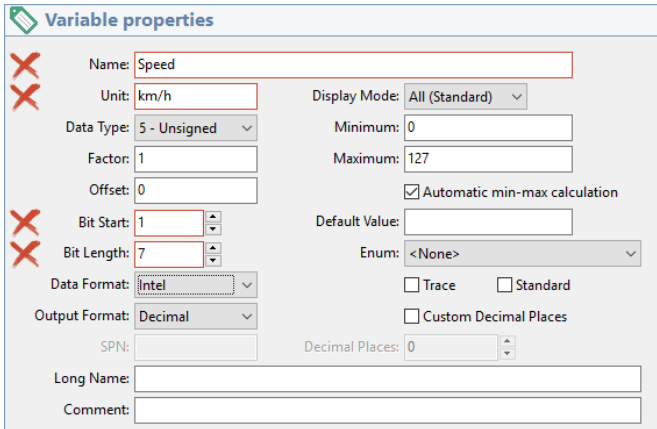

The screenshot shows the 'Variable properties' dialog box for a variable named 'Speed'. The dialog is divided into two columns. The left column contains fields for Name, Unit, Data Type, Factor, Offset, Bit Start, Bit Length, Data Format, Output Format, SPN, Long Name, and Comment. The right column contains fields for Display Mode, Minimum, Maximum, Automatic min-max calculation, Default Value, Enum, Trace, Standard, Custom Decimal Places, and Decimal Places. Red 'X' marks are placed to the left of the Name, Unit, Bit Start, and Bit Length fields, indicating they are required or highlighted. The values are: Name: Speed, Unit: km/h, Data Type: 5 - Unsigned, Factor: 1, Offset: 0, Bit Start: 1, Bit Length: 7, Data Format: Intel, Output Format: Decimal, SPN: (empty), Long Name: (empty), Comment: (empty), Display Mode: All (Standard), Minimum: 0, Maximum: 127, Automatic min-max calculation: checked, Default Value: (empty), Enum: <None>, Trace: unchecked, Standard: unchecked, Custom Decimal Places: unchecked, Decimal Places: 0.

7. Add the Engine variable to Multiplexer2 by using **Add Variable** and adjust the entries according to the shown example.

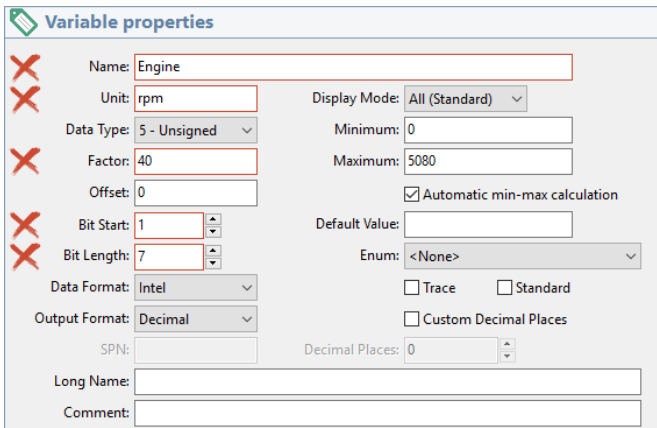

The screenshot shows the 'Variable properties' dialog box for a variable named 'Engine'. The dialog is divided into two columns. The left column contains fields for Name, Unit, Data Type, Factor, Offset, Bit Start, Bit Length, Data Format, Output Format, SPN, Long Name, and Comment. The right column contains fields for Display Mode, Minimum, Maximum, Automatic min-max calculation, Default Value, Enum, Trace, Standard, Custom Decimal Places, and Decimal Places. Red 'X' marks are placed to the left of the Name, Unit, Factor, Bit Start, and Bit Length fields, indicating they are required or highlighted. The values are: Name: Engine, Unit: rpm, Data Type: 5 - Unsigned, Factor: 40, Offset: 0, Bit Start: 1, Bit Length: 7, Data Format: Intel, Output Format: Decimal, SPN: (empty), Long Name: (empty), Comment: (empty), Display Mode: All (Standard), Minimum: 0, Maximum: 5080, Automatic min-max calculation: checked, Default Value: (empty), Enum: <None>, Trace: unchecked, Standard: unchecked, Custom Decimal Places: unchecked, Decimal Places: 0.

Using the symbol format 6.0, it is possible to define signals instead of variables. Signals are defined for the whole file

independent of symbols and then can be used repeatedly afterwards. For this example a Temperature signal is created and added to both multiplexers.

- Use **Add Signal** for the new Temperature signal and adjust the entries according to the shown example.

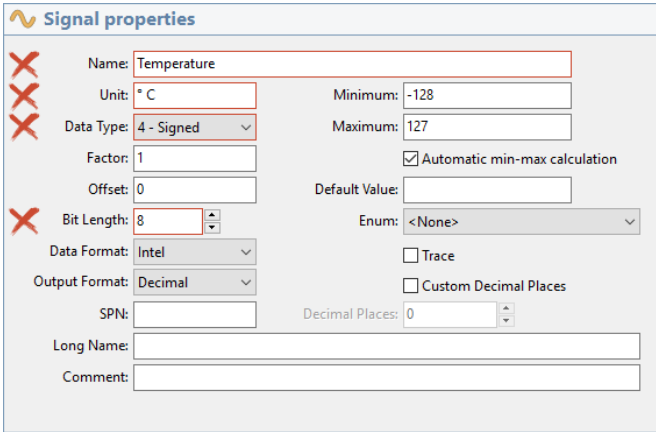

**Signal properties**

Name:

Unit:  Minimum:

Data Type:  Maximum:

Factor:   Automatic min-max calculation

Offset:  Default Value:

Bit Length:  Enum:

Data Format:   Trace

Output Format:   Custom Decimal Places

SPN:  Decimal Places:

Long Name:

Comment:

- Assign the signal to both multiplexers by selecting each multiplexer in the Item Navigator and then **Assign Signal**, the sub item of Add Signal.
- Use **Save as** to save the symbol file with the name `MuxSymExample.sym`.

The following figures show the two display possibilities for multiplexers on the PCAN-Diag FD screen:

In the common view, the variables of all multiplexers are shown in a single list. If the given name and all parameters of a variable are identical for all multiplexers, this variable is only listed once.

In the separate view, each multiplexer definition is shown as separate group (as known from the PCAN-Explorer).

The view is determined in the Windows program PCAN-Diag FD Editor when adding symbol files on the Symbols tab.

### 5.3.3 Reducing a Symbol File's Size

Because of the limited working memory in the PCAN-Diag FD, symbol files can only be read up to a specific size (see also beginning of section 5.3 on page 42). One possibility to reduce the size of a symbol file is using the Display Mode property.

You can find **Display Mode** in the properties of symbols, multiplexers, and variables.

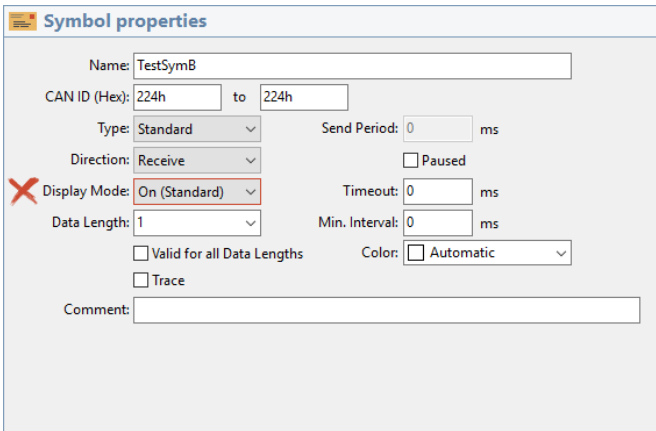

The screenshot shows the 'Symbol properties' dialog box. The 'Display Mode' property is highlighted with a red box and a red 'X' icon to its left. The 'Display Mode' is currently set to 'On (Standard)'. Other properties include Name: TestSymb, CAN ID (Hex): 224h to 224h, Type: Standard, Direction: Receive, Data Length: 1, Send Period: 0 ms, Timeout: 0 ms, Min. Interval: 0 ms, Color: Automatic, and Comment: (empty).

**Display Mode** property in a symbol definition

The default for this property is **On**. If **Off**, the element is not processed by the PCAN-Diag FD Editor anymore. When transferring a project to the PCAN-Diag FD, elements with Display Mode Off are not compiled into the binary symbol file (\*.syb).

Using this method you can reduce a symbol file's size without deleting symbols, multiplexers, or variables.

## 5.4 CAN Traffic Recording

➤ Menu item **CAN Data** > **Trace Messages**

With this function, the incoming CAN traffic is recorded to a trace file on the internal memory card of the PCAN-Diag FD. Also the timing of the CAN messages is regarded.

Later, a trace file can be used for playback of the recorded CAN messages on the CAN bus (see section 5.5 on page 58). Alternatively, the file can be analyzed or played back on a PC.

Display	Meaning
<b>Drive</b>	Name of the used data carrier. The <b>MO:</b> indicator stands for the internal memory card.
<b>Folder</b>	The directory on the data carrier where the trace files are stored. This path is fixed ( <b>Traces</b> directory in the active project directory branch).
<b>File</b>	Name of the trace file that is used for the next recording. The file name is automatically generated from the current date, but can be changed by clicking on it.

### 5.4.1 Settings for Tracing

#### Overwrite

Setting	Description
<b>[x]</b>	If the given <b>File</b> already exists, it will be overwritten.
<b>[ ]</b>	If the specified <b>File</b> already exists, a new file name is created by appending a sequential number. The initial file is preserved.



### Max. Size

Specifies the maximum size of a recording (values of 10 up to 500 MByte). The behavior when reaching the maximum size results from the **Multi file** setting (see below).

### File format

Setting	Description
<b>.btrc (binary)</b> (recommended)	The recording is done with the binary trace file format (*.btrc). For further use on a PC, conversion with the Windows software PEAK-Converter is required (see section 5.6 on page 59).
<b>.trc (ASCII)</b>	The recording is done in PEAK-System's text trace format 2.0 which can be used directly, for example in PCAN-Explorer. NOTE: Use this format for recording only at low bus load (e.g. max. 30 % at 500 kbit/s) to avoid data loss during recording.

### Multi file

Setting	Description
<b>[x]</b>	If <b>Max. Size</b> of the trace file is reached, the recording is continued in a new file. The given <b>File</b> name is supplemented by a consecutive number.
<b>[ ]</b>	If <b>Max. Size</b> of the trace file is reached, the recording is stopped automatically.

### Data

Regular CAN messages are recorded.

### Errors

Error frames and the error counters of the CAN controller in the PCAN-Diag FD are recorded.

## Status

Status changes of the CAN controller in the PCAN-Diag FD are recorded (Warning Level, Error Passive, Bus Off).

### 5.4.2 Performing Recording

▶ Start a recording with the hotkeys:

1. Make sure that no USB connection is present between the PCAN-Diag FD and a PC.
2. Use **START** to initiate the recording.

During the process, the size of the trace file is indicated in kByte.

3. You can **PAUSE** the recording or **STOP**. It automatically ends when reaching the maximum file size as long as the **Multi file** is not enabled.



**Note:** In battery mode, the device remains switched on as long as a trace is being recorded. This may cause the battery to run down before the trace recording is stopped. We recommend using an external power supply for longer trace recordings.

## 5.5 Playing Back Recorded CAN Traffic

➤ Menu item **CAN Data** > **Play Back Trace**

The PCAN-Diag FD can play back CAN messages from a trace file (\*.trc or \*.btrc) onto the connected CAN bus. The timing of the CAN messages, as it occurred originally during recording of the trace file, is maintained.

**Note:** On the PCAN-Diag FD, there may be transmission delays of CAN messages when playing back trace files in text format (\*.trc). For delay-free playback, the contents of the trace file should not generate a bus load higher than 30 % at 500 kbit/s. For recording and playback, we recommend the binary trace format (\*.btrc).

Do the following to play back a trace file:

1. Click on **SelectFile** and select a trace file (\*.trc or \*.btrc) from the project directory.
2. Set the number of repetitions of the trace file with **Loop mode**. Select **infinite** for a continuous playback of the recording.
3. Press the hotkey **PLAY** to start the playback. Afterwards, you have the following possibilities:

Function	Executed action
<b>PAUSE</b>	Pauses the playback. <b>PLAY</b> continues the playback at the point where it was interrupted before.
<b>STOP</b>	Ends the playback.

## 5.6 Using Recorded CAN Traffic on the PC

The recorded CAN traffic can be read by a PC via a USB connection from the internal memory card of the PCAN-Diag FD. The trace files \*.trc or \*.btrc are in the `Traces` subdirectory of the current project.

For further use of binary-coded trace files \*.btrc, you must convert the data into an appropriate format. The Windows program PEAK-Converter is available on the website of PEAK-System and on the internal memory card of the PCAN-Diag FD for this purpose.

## Possible conversion targets:

Target format	File name extension	Explanation/usage
PCAN-Trace	.trc	Text-based trace format by PEAK-System; viewing of the data in the PCAN-Explorer or playback of the CAN messages with the PCAN-Trace program. <b>Tip:</b> In connection with the trace files of the PCAN-Diag FD, we recommend to use the format version 2.0 as target format due to the CAN FD support.
Vector ASC Trace	.asc	Text-based trace format by the company Vector Informatik that also can be used by some third-party programs.
Character Separated Values (CSV)	.csv	Common, text-based format for import into a spreadsheet (semicolon as separator).

► For further use of the binary-coded trace data proceed as follows:

1. Connect the PCAN-Diag FD to a PC with the provided USB cable (see also chapter 11 on page 93).
2. Under Windows, launch the `PEAK-Converter.exe` program from the internal memory card of the PCAN-Diag FD and there from the following directory:  
`\PCAN-Diag FD\Tools\PEAK-Converter\`
3. As source, select a binary-coded trace file (`*.btrc`). The trace files are located in the corresponding project directory branch:  
`\ PCAN-Diag FD\Projects\<<project name>\Traces\`
4. Specify a destination file and select the desired target format (see above).

## 6 Measuring Functions for the CAN Bus

- Main menu item **Measurements**

This chapter describes the measurement functions of the PCAN-Diag FD. The oscilloscope function is covered in the following chapter 7 on page 68.

### 6.1 Bus Load

- Menu item **Measurements** > **Bus Load**



**Tip:** You can adjust the busload settings quickly to different applications by means of projects (see chapter 8 on page 81).

As long as no message is transmitted on the CAN bus, it is in idle state. The busload is the ratio of the durations of the idle state and CAN traffic. 0 % corresponds to no CAN traffic at all. 100 % corresponds to transmission of one CAN frame after the other without any idle state in between. The percentage utilization of the CAN bus with CAN messages is shown in a graph over a period of time and is continuously updated.

The **busload graph** is put together out of sampling intervals whose duration results from the set CAN bit rate and the given number of **Samples per bar**. Per sampling interval, the average value (yellow bar) and/or the maximum value (red bar) are determined and displayed. The current average value is additionally indicated by **Current bus load**.

The **error rate graph** represents the number of errors (error frames) per second with blue bars. It is shown if the corresponding setting is enabled (see below).

You can counteract a generally high bus load with the following, basic **measures**:

- └ Raise the CAN bit rate of all CAN nodes on the bus.
- └ Increase the cycle time of specific messages in the CAN net in order to reduce their emergence (less CAN messages per time).

### 6.1.1 Taking a Busload Screenshot

With the **SAVE BMP** hotkey, a bitmap screenshot of the busload screen is saved onto the internal memory card (file name: pict000.bmp with consecutive numbers).

On the internal memory card, the files are written to the directory of the active project (`Projects > <project name>`). Get the name of the active project from the lower status bar in the main menu.

Access to the saved files is achieved from a PC via a USB connection. See chapter 11 on page 93.

### 6.1.2 Settings for Busload Measurement

With the **SETTINGS** hotkey, the screen for those settings is shown that refer to the display of the busload measurement.

```
Show busload
Show max. busload
Show errors
```

The first two options determine which values are displayed in the bus load graph:

- └ Average (yellow bars)

### └ Maximum (red bars)

The busload graph is always displayed (at least one option active).

In an additional graph, the error rate can be displayed with blue bars.

#### **Y-scale max. busload (%)**

The maximum percentage value that the bus load graph can represent. All bars with exceeding values will be truncated at the top.

Default value: 10

#### **Y-scale max. busload (%)**

The maximum number of errors per second that the error rate graph can represent. All bars with exceeding values will be truncated at the top.

Default value: 10

#### **Samples per bar**

The number of measuring values (samples) that are used for calculation of one bar of the graph.

Default value: 10

## 6.2 CAN Bus Termination

➤ Menu item **Measurements** > **CAN Termination**

The function measures the resistance value between the CAN-Low and CAN-High lines. While doing so the CAN traffic is not affected.

A High-speed CAN bus (ISO 11898-2) must be terminated on both ends with 120 Ohm between the CAN lines CAN-Low and CAN-High. This measure will prevent signal reflections at the cable ends and a correct function of CAN transceivers attached to the CAN bus is assured.

The two termination resistors in parallel result in a total resistance of 60 Ohm. The measurement of the total resistance provides information about a correct CAN bus termination.



**Note:** The switchable internal termination of the PCAN-Diag FD is included in the termination measurement on the CAN bus.

## Performing the Measurement

In the **Start measurement** entry, click on **Start**.

The resistance measurement is updated about every second (**Status: Running**) until you click on **Stop** (**Status: Stopped**). The result of the last measurement is displayed in the **Result** line and also graphically in a bar graph.

Measuring Result	Meaning
≈ 60 Ohm	The termination at the CAN bus is ok in terms of measurement. Make sure that the termination resistors are positioned at each end of the bus and not, for example, at taps in the middle of the bus.
≈ 120 Ohm	Only a single terminating resistor is present. Install a further 120-Ohms resistor.
< 45 Ohm	Too many terminating resistors are inserted in the CAN bus. A reason may be that on one bus end both a separate termination resistor as well as a CAN node with internal termination are installed.
--- Ohm	The measurement has not yet been performed or was not successful.



Measuring Result	Meaning
Termination missing	No terminating resistor or a too large one (> 1,2 kΩ) is present on the CAN bus. Set up a <u>correct</u> termination.
Shorted	Short circuit (< 10 Ω). Check if the PCAN-Diag is connected properly.
Jumping value	Check if the PCAN-Diag is connected properly. For example, the CAN lines CAN-High and CAN-Low could have been swapped on the CAN bus.

### Int. CAN termination

If **On**, the internal termination resistor (124 Ohm) is activated.

Altering the settings at this place keeps it only temporarily (until the device is switched off). The internal termination can be set permanently in the general settings (main menu item **Settings**).

### Calibration

The measuring device for the termination resistance must be calibrated to avoid a major deviation of the measured value from the actual resistance value. A performed calibration is indicated by its date.

If **No calib.** is shown or the measured values are not plausible, a calibration of the resistance measurement can be performed via the menu entry **Support** > **Calibration CAN Termination** (see 9.7 on page 91).

## 6.3 Voltages on the D-Sub Connector

➤ Menu item **Measurements** > **Analog**

The voltage levels for pins 6 and 9 of the D-Sub connector are measured and shown in the graph. The measuring range extends from -28 V to +28 V.

### Customizing the Graph Display

The settings for customizing the graph display are reached via the **SETTINGS** hotkey.

#### Show Pin 6 Voltage

The voltage on pin 6 of the D-Sub connector is shown.

 **Note:** Pin 6 may be connected to ground within the device. This is determined in the general settings (see 4.3.1 *D-Sub GND connection* on page 30).

#### Show Pin 9 Voltage

The voltage on pin 9 of the D-Sub connector is shown.

#### Samples per bar

The number of measuring values (samples) that are used for calculation of one bar of the graph.

Default value: 10

#### Min. Voltage [V]

The minimum value of the voltage that is to be shown in the graph.

Default value: -30

### Max. Voltage [V]

The maximum value of the voltage that is to be shown in the graph.

Default value: 30

### Taking a Screenshot

With the **SAVE BMP** hotkey, a bitmap screenshot of the busload screen is saved onto the internal memory card (file name: pict000.bmp with consecutive numbers).

On the internal memory card, the files are written to the directory of the active project (Projects > <project name>). Get the name of the active project from the lower status bar in the main menu.

Access to the saved files is achieved from a PC via a USB connection (see chapter 11 on page 93).

# 7 Oscilloscope Function (Scope)

- Main menu item **Scope**

The oscilloscope function of the PCAN-Diag FD is used for in-depth diagnosis of the CAN signals on the connected lines CAN-High and CAN-Low. It is independent of the CAN communication in the PCAN-Diag FD. Therefore, it provides a further instance for troubleshooting on the CAN bus. Besides the pure display of the signal course and measuring possibilities with cursors, the oscilloscope function also shows statistical information. Handling is similar to a standard storage scope.

## 7.1 Properties of the Oscilloscope Function

- └ Two independent measurement channels, each with a maximum sample rate of 100 MHz
- └ Display of the CAN-High and the CAN-Low signal as well as the difference of both signals
- └ Trigger configuration to various properties of CAN messages:
  - Start and end of a frame
  - CAN errors
  - CAN ID
  - Bit Rate Switch of CAN FD frames
- └ External measurement devices can be triggered using the banana jack, 4 mm
- └ Depiction of raw CAN and CAN FD frames

- └ Decoding of CAN and CAN FD frames from the recorded signal course
- └ Display of various properties and of measuring data of the decoded CAN frame using the Report function
- └ Current view can be saved as bitmap screenshot
- └ Memory depth can be set to up to 1 Megasamples
- └ Saving sample data as CSV file
- └ Time measurement with a resolution of up to 10 ns

## 7.2 Elements of the Oscilloscope Screen

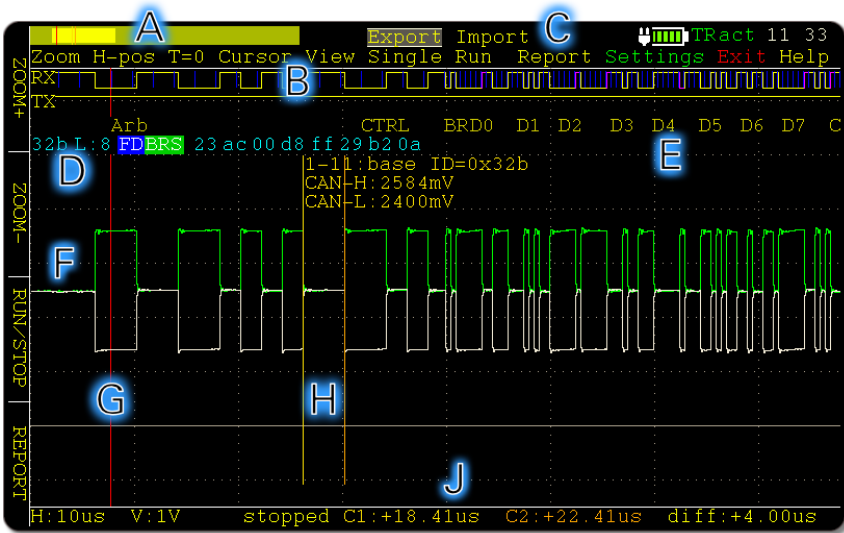

- A:** Position bar for overview of the sample buffer (current view, trigger, measuring cursors)

- B: Yellow courses: digital data of the CAN transceiver for reception (**RX**) and transmission (**TX**, usually ACK and transmitted active error frames); violet: stuff bits  
Blue lines: sample points of the CAN controller
- C: Actions (see the following manual sections)
- D: CAN data decoded from signal course
- E: Markers detected in the CAN frame from signal course.
  - Arb**: Arbitration phase (comprises ID, RTR, RRS, SRR, IDE)
  - CTRL**: Control Field (comprises IDE, FDF, DLC, BRS, ESI)
  - BRS**: Bit Rate Switch for CAN FD
  - D0** ... **D63**: Data bytes with 8 bits each
  - CRC**: Check sum
  - EOF**: End Of Frame
- F: Signal courses CAN-High (green) and CAN-Low (white), display of the difference alternatively (blue, not shown here)
- G: Trigger position (red)
- H: Measuring cursors C1 (orange) for voltage level and CAN frame field, C2 (orange-red) for time interval measurement
- J: **H**: grid of time axis (horizontally)  
**V**: grid of voltage axis (vertically)  
**Stopped/Waiting/Running**: trigger status  
**C1/C2/Diff**: relative time measuring values of the measuring cursors

## 7.3 Adjusting the View

- Functions **Zoom**, **H-pos**, and **T=0**

With the following functions the current view on the horizontal axis (time axis) is adjusted.

Element	Function
<b>Zoom</b>	Zooming in or out horizontally. The reference point during zooming yields from <b>Settings</b> > <b>Display trigger position</b> .
<b>H-pos</b>	Shifting the view horizontally.
<b>T=0</b>	Aligns the view to the trigger position. The trigger position is placed on the screen according to <b>Settings</b> > <b>Display trigger position</b> .

The position bar on the top of the oscilloscope screen gives an overview.

## 7.4 Measuring a Time Period

- Function **Cursor**

A section of the time axis can be marked on the screen with the two cursors C1 and C2 (vertical lines) in order to measure a time period.

▶ Do the following to measure a time period:

1. Select **Cursor** > **Cursor1 coarse**. Set the desired start point of the time period by dialing and finally pushing the button. For fine-tuning the cursor position use **Cursor** > **Cursor1 fine**.



**Tip:** You can measure a large time period with the highest possible time resolution by zooming in (**Zoom**) before

positioning the cursor. Then the cursor can be positioned with a finer time resolution that will not be lost when zooming out afterwards.

2. Repeat the procedure with Cursor2 in order to set the end point of the time period. This must be positioned to the right of the start point.
3. In the lower status bar, read the relative position of the cursor to the trigger position (**C1**, **C2**) and the length of the **Diff** period.

## 7.5 Customize the View

### ➤ Function **View**

You can customize the view of information on the oscilloscope screen by showing selected elements. This is done by selections in the displayed menu.

**OK** applies the selection temporarily, **SAVE&OK** saves the selection throughout switching off the device. **Exit** leaves the menu without changes in the view.

Element	View	Description
<b>CAN-H</b>	Upper, green signal course	CAN-High of the differential CAN signal
<b>CAN-L</b>	Lower, white signal course	CAN-Low of the differential CAN signal
<b>CAN-Diff</b>	Blue signal course	Difference of CAN-High and CAN-Low
<b>CAN_RxD</b>	RX bar in the upper area	Bit borders and bit states of received signals
<b>CAN_TxD</b>	TX bar in the upper area	Bit borders and bit states of transmitted signals



<b>Decoder</b>	Turquoise-colored CAN frame data	Data of the CAN frame decoded from the signal course
<b>Bit fields</b>	Khaki-colored field descriptors	View of the fields of the decoded CAN frame

## 7.6 Sampling Signals

➤ Functions **Single/Stop** and **Run/Stop**

The sample buffer is filled with the signal course as soon as a trigger event is detected. To sample **once**, click on **Single**. Use **Run** to activate **repeated** sampling. Use **Stop** for each action to end.

You can select the **trigger event** to be used with **Settings** > **Trigger**. **Settings related to the sampling** are adjusted with **Settings** > **Pretrigger size** and **Sample buffer size**. For more information about these settings, see section 7.9.3 on page 78 and following.

### 7.6.1 Decoding of the Signal Course

A CAN frame detected in the signal course is automatically decoded. In the upper area of the grid, the contents of the decoded CAN frame (turquoise-colored: CAN ID, data length in bytes, payload data) and its bit fields (khaki-colored) are shown.



**Tip:** If this information is not shown, select **View** and check the items **Decoder** and **Bit fields**.

If more than one CAN frame is contained in the sample buffer, that one is decoded that is placed farthest to the left in the current view.

## 7.6.2 Fixing Decoding Problems

Decoding display	Meaning	Possible measure(s)
Red data	Faulty CAN frame	Set the device's CAN bit rate to the one on the connected CAN bus: - main menu entry <b>Settings</b> > <b>Bit rate</b> - as alternative: <b>Detect CAN bit rate</b>
	No remote CAN node transmitting an acknowledge*	- Running more than one active node on the CAN bus - Running PCAN-Diag without listen-only mode
Empty	No CAN frame detected	Shift the current view with <b>H-pos</b> until a CAN frame is shown.
	The Decoder element for the oscilloscope screen is disabled	Enable the Decoder element view: <b>View</b> > <b>Decoder</b>

\* If bitfields of frames are displayed at decoding, the "noack" error appears at the end of the frame.

## 7.7 Showing a Report about the Decoded CAN Frame

### ➤ Function **Report**

With this function you get an overview of the properties of a decoded CAN frame.

Property	Description
<b>Configuration</b>	Section with the current CAN settings. They can be changed in the main menu item <b>Settings</b> .
Protocol	CAN protocol
Arb. Bitrate	Nominal bit rate (incl. indication of the sample point)
Data bitrate	Data bit rate at CAN FD (incl. indication of the sample point)

Property	Description
Term. Status	Status of the CAN termination:
Term. value	Measured total resistance between CAN-High and CAN-Low
<b>Measurement</b>	Section with measuring values that yield from the decoding of the CAN frame
Protocol	CAN protocol that the decoded CAN frame is using (BRS: bit rate switch at CAN FD)
CAN ID	CAN ID
Data length	Data length in bytes
(Data)	Data in hexadecimal format or "RTR" (Remote Transmission Request)
Total bits	Number of bits in the whole CAN frame
Dominant bits Recessive bits	Number of dominant and recessive bits in the whole CAN frame
Stuff bits	Number of stuff bits in the whole CAN frame
Fixed Stuff bits	Number of stuff bits that are predetermined by CAN FD for the CRC bitfield
Err. state ind.	Error state indicator that has been set in the CAN FD frame by the transmitting CAN node
CRC15, CRC17, CRC21	Checksum for the CAN frame; depending on the CAN frame type, another CRC algorithm is used
Stuff count	Only CAN FD frame with ISO format: Additional check information in the frame referring to the stuff bits
Bitrate	Bit rate (incl. deviation to the set bit rate)
Arb. bitrate Data bitrate	Only CAN FD frames with BRS: nominal bit rate and data bit rate (incl. deviations to the set bit rates)
ACK field width	<p>Actual duration of the acknowledge bit (response of all receiving CAN nodes) incl. relation to the theoretical duration of a bit timing.</p> <p>A greater deviation upwards may indicate a larger distance to a responding CAN node or a delayed processing of a CAN node.</p>

## 7.8 Saving the Scope Screen and the Sample Buffer Contents

➤ Functions **Export** and **Import**

According to **Settings** > **Export**, this function saves the following data to the internal memory card:

- └ the contents of the screen as bitmap (`pict000.bmp`)
- └ the contents of the sample buffer as CSV file (`data000.csv`), for use in Excel, for example, or for re-importing into the sample buffer with the **Import** function.
- └ a text file with information from the Report function (`report000.txt`)

The saving can take several seconds. During this operation, a progress bar is displayed. The files are written to the directory of the active project (`Projects > <project name>`) and can be read later from a connected PC via USB. Get the name of the active project from the lower status bar in the main menu.

## 7.9 Settings for the Oscilloscope Function

➤ Menu item **Scope** > **Settings**

### 7.9.1 Trigger

Selection of the event that triggers the sampling of the signals (trigger event).

Setting	Description
<b>None</b>	No trigger function
<b>Start of Frame</b>	Start of a recognized CAN frame
<b>End of Frame</b>	End of a recognized CAN frame
<b>Error Frame</b>	Error frame (6 dominant bits)
<b>Free-running</b>	Free-running sampling without trigger; the sample buffer is filled repeatedly.
<b>CAN ID</b>	CAN frame with the CAN ID being indicated in the following setting (item 7.9.2)
<b>---</b>	(Reserved)
<b>CAN Rx falling</b>	Transition of a received CAN signal from the dominant to the recessive state
<b>Bitrate Switch</b>	Bit rate switch flag of a CAN FD frame

### 7.9.2 CAN ID

If **CAN ID** is selected as trigger event, the CAN ID indicated here is used.

Setting	Description
<b>Frame format</b>	Length of the CAN ID (11 bit or 29 bit)
<b>CAN ID</b>	Enter the CAN ID in hexadecimal format

### 7.9.3 Sample buffer size

Determines the buffer size and thus the sampling duration. Smaller buffer sizes are useful for a faster repetition of the sampling run.

The sampling time results from the quotient of the sample buffer size and the sample rate of 100 MSamples/s.

Example: 1024 kSamples / 100 MSamples/s = 10.24 ms

### 7.9.4 Pretrigger size

A part of the signal course is shown before the trigger point. The percentage indicates the part of the whole course. Possible ratios: 10:90, 50:50, 90:10

### 7.9.5 Display trigger position

The trigger position (red vertical line) can be displayed on the left, in the middle, or on the right of the oscilloscope screen after the sampling process. Furthermore, this setting determines the reference point for zooming.

### 7.9.6 Hotkeys

Within the oscilloscope function, the different functions can be assigned to the four hotkeys.

Setting	Description
None	No function
Zoom+, Zoom-	Zoom in or out horizontally
H-pos+, H-pos-	Shift the view horizontally
Frame+, Frame-	Jump to the next or the previous recognized CAN frame in the signal course
Single, Run/Stop	Start the sampling process, either once or repeatedly

Setting	Description
<b>Report</b>	Open the overview of the properties of a decoded CAN frame
<b>T=0</b>	Align the view to the trigger position
<b>Save</b>	Save the settings in the device
<b>Exit</b>	Leave the oscilloscope function
<b>Export</b>	Save data to the internal memory card according to the presets
<b>Import</b>	Import a CSV file into the sample buffer for subsequent viewing of a signal course

### 7.9.7 View

The view of information on the oscilloscope screen can be customized by showing selected elements.

Element	View	Description
<b>CAN-H</b>	Upper, green signal course	CAN-High of the differential CAN signal
<b>CAN-L</b>	Lower, white signal course	CAN-Low of the differential CAN signal
<b>CAN-Diff</b>	Blue signal course	Difference of CAN-High and CAN-Low
<b>CAN_RxD</b>	RX bar in the upper area	Bit borders and bit states of received signals
<b>CAN_TxD</b>	TX bar in the upper area	Bit borders and bit states of transmitted signals
<b>Decoder</b>	Turquoise-colored CAN frame data	Data of the CAN frame decoded from the signal course
<b>Bit fields</b>	Khaki-colored field descriptors	View of the fields of the decoded CAN frame

### 7.9.8 Export

Here it is determined which files are written to the internal memory card when the Export function is executed:

- └ **Screendump**: the contents of the screen as bitmap  
(pict000.bmp)
- └ **Report**: a text file with information from the Report function  
(report000.txt)
- └ **CSV data**: the contents of the sample buffer as CSV file  
(data000.csv)



## 8 Configuring the Device with Projects

- Main menu item **Projects**

With projects the PCAN-Diag FD can quickly be adapted to different applications.

A project contains the following elements:

Project element	Assigned area in the PCAN-Diag FD
General Settings	<b>Settings</b>
Oscilloscope settings	<b>Scope &gt; Settings</b>
Settings for the view of CAN messages	<b>CAN Data &gt; Raw CAN Messages &gt; Settings</b>
Display settings for busload and voltage measurements	<b>Measurements &gt; Bus Load &gt; Menu &gt; Settings</b> <b>Measurements &gt; Analog &gt; Settings</b>
CAN transmit lists	<b>CAN Data &gt; Raw CAN Messages</b>
CAN transmit sequences	<b>CAN Data &gt; Raw CAN Messages</b>
Symbol files	<b>CAN Data &gt; Manage Symbol Files</b>
Alternative splash screen	Shown when device is started (see section 8.2 on page 86)

Using projects:

- Projects are created and altered on a PC with the provided Windows software PCAN-Diag FD Editor and then are transferred to the internal memory card of the PCAN-Diag FD.
- Any number of projects can be saved to the internal memory card (only limited by the left space on the internal memory card).
- During work with the PCAN-Diag FD a project can be loaded from the internal memory card.

- If a new version of the active project is available on the internal memory card, the project is automatically reloaded during startup of the PCAN-Diag FD.
- Device-internal changes of the settings or of CAN transmit lists alter the affiliated project on the internal memory card only if **Save Project** is selected (see below).

### Load Project

A project is selected from the internal memory card; the project's elements are loaded into the PCAN-Diag FD. Click on the name of the desired project in order to load it.



**Note:** When loading a project from the internal memory card, all current settings, transmit lists, and symbol files in the PCAN-Diag FD are discarded.

The **Default project** contains default settings for the PCAN-Diag FD.

### Save Project Save Project as

Save the current settings, transmit lists, and symbols files to the currently loaded project file. Alternatively, you can create a new project with a different name.

### Create new Project

Based on the Default project, a new project with a new name is created on the internal memory card of the PCAN-Diag FD.

### Copy Project

Opens the list of all projects that are saved on the PCAN-Diag FD and offers the possibility to save the selected project as basis for a new project.

## Delete Project

Opens the list of all projects that are saved on the PCAN-Diag FD and offers the possibility to delete a project by clicking on it.

## Project:

Shows the name of the active project.

At startup the PCAN-Diag FD checks if the project file on the internal memory card with the same name is newer than the initially loaded version. An updated project is automatically loaded.

## 8.1 Creating and Loading a Project

The procedure from creation of a project under Windows to the use in the PCAN-Diag FD is divided into three phases:

- A) Creating a project on a PC with the Windows program PCAN-Diag FD Editor.
- B) Transferring the project to the internal memory card of the PCAN-Diag FD via USB connection.
- C) Loading the project in the PCAN-Diag FD.

▶ Do the following to create a project:

1. Start the Windows program PCAN-Diag FD Editor (`PcanDiagFdEdt.exe`), e.g. from the internal memory card of the PCAN-Diag FD (directory `\PCAN-Diag FD\Tools\`).

The elements of a project are listed on the tabs.

2. Save the created project on a data carrier with **Save**. This is required if you want to add CAN transmit lists and transmit sequences to the project. The given file name is from now on used as project name and should be unique.



**Tip:** For each new project, create a separate directory where you provide the project file and the additional files from the following steps.

3. Adjust the settings for your application on the tabs **Settings**, **Scope Settings**, **CAN Data**, and **Measurements**. See the Information column for explanations for each element.
4. If needed, add one or more **CAN Transmit Lists** on the corresponding tab. Create new lists with the Windows software PCAN-View by tabling the desired CAN messages in the Transmit window and saving this list. Afterwards, import it into the PCAN-Diag FD Editor.
5. If you want to use transmit sequences, insert them on the **CAN Sequence Lists** tab. Import regular transmit lists from our PCAN-View software. The “Cycle Time” of the CAN messages is interpreted as the “Delay” to the previous message in the list.
6. On the **Symbols** tab, select the symbol files to be available for the project.

Configure the presentation of multiplexers of all symbols files with **Target format**:

**Common Multiplexer:** All variables of different multiplexers are displayed in a common list.

**Separate Multiplexer:** Variables are listed for each multiplexer.

For adding, use the **Import** button.

7. Save the created project on a data carrier with **Save**.

▶ Do the following to transfer the project to the PCAN-Diag FD:

1. Connect the PCAN-Diag FD to a PC with the provided USB cable (see also chapter 11 on page 93).

The **Transfer to** button in the PCAN-Diag Editor is not dimmed anymore but blue indicating the possibility for transfer. A text note in the lower **Output** panel indicates that the PCAN-Diag FD has been recognized.

2. Click on **Transfer to** and check the PCAN-Diag FD device in the dialog box **Select Devices**.



**Tip:** You can transfer the same configuration to several PCAN-Diag devices at the same time if those are connected to the PC. Select all devices with **Select All**.

3. Click on **OK**.

The project file (\*.prj) and the affiliated symbol files, transmit lists, and transmit sequences (\*.sym, \*.syb, \*.xmt, \*.xms) are transferred to the PCAN-Diag FD (progress indicator **Transfer data**). The used directory on the internal memory card is

```
\PCAN-Diag FD\Projects\\.
```

4. Terminate the USB connection between the PC and the PCAN-Diag FD.

▶ Do the following to load the project in the PCAN-Diag FD:

1. In the PCAN-Diag FD select **Projects** > **Load Project**.

A list with projects available on the internal memory card and the remaining memory space on the internal memory card are shown.

2. Select the project that has been transferred before.

The project is now loaded and is shown as active project. The active project is indicated at the lower edge in the main menu.



**Tip:** You can get further information about the use of the PCAN-Diag FD Editor in the program's help which is invoked via **Help** or the **F1** key.

## 8.2 Integrating an Alternative Splash Screen

Each project can have an alternative splash screen in order to clarify already at startup which project is active. A bitmap file must be put into the corresponding project directory on the internal memory card. If it does not exist, the default splash screen is shown (Default project).

### Properties of the splash screen

File name	Intro_vert.bmp
Storage path on the internal memory card	\PCAN-Diag FD\Projects\ <project name="">\</project>
Format	Windows bitmap
Resolution	480 x 800 pixels
Color depth	24 bit

▶ Do the following to integrate an alternative splash screen:

1. On a PC, create a bitmap file with the key features listed in the table.
2. Establish a USB connection between the PC and the PCAN-Diag FD.

In the PC the PCAN-Diag FD is handled as mass storage device.

3. Copy the created file `Intro_vert.bmp` into the desired project directory (see table).
4. Disconnect the USB connection.

## 9 Maintenance Functions for the Device

- Main menu item **Support**

The page gives an overview about the device's internals. The individual details are usually taken for support purposes.

In this menu, hardware functions are available for maintenance of the device. They are described briefly in the following.

 **Important note:** Misapplication of some functions can lead to the unavailability of the device.

### 9.1 Updating the Firmware

- Submenu item **Update Firmware**

On the website of PEAK-System, the package for the PCAN-Diag FD is available containing all necessary files for the operation of the device: [www.peak-system.com/quick/DL-Packages-E](http://www.peak-system.com/quick/DL-Packages-E)

Beside others, the package contains the current firmware file.



**Tip:** In addition to the firmware, we recommend that you keep the device help and the Windows tools on the PCAN-Diag FD up to date. See 11.4 *Update of the Provided Tools for Windows* on page 94.

▶ Do the following to update the firmware:

**i Important note:** The current settings in the device are lost during a firmware update. Before a firmware update, make sure that these are stored on the internal memory card (**Project** > **Save Project**) or are available as project in the Windows program PCAN-Diag FD Editor.

1. Make sure that the PCAN-Diag FD is supplied externally (plug icon at the charging level indicator on the upper right).
2. Via a USB connection from your PC (chapter 11 on page 93), copy the new firmware file (\*.bin) to the internal memory card of the PCAN-Diag FD into the following directory:  
/PCAN-Diag FD/Firmware/

3. On the PCAN-Diag FD, select **Support** > **Update Firmware**.

4. Select the previously copied firmware file.

The PCAN-Diag FD directly starts with the firmware update. This process takes a few seconds.

5. If a corresponding note appears on the screen, disconnect the power supply from the PCAN-Diag FD before restarting.
6. Confirm the final message by pressing the push dial.  
The PCAN-Diag FD switches off.

7. With the push dial, switch the PCAN-Diag FD on again.

The update process is completed and you can use the device regularly.



## 9.2 Starting the Bootloader

- Submenu item **Start Bootloader**

Starts the bootloader with a menu containing basic functions.

## 9.3 Restoring the Factory Defaults

- Submenu item **Restore Factory Defaults**

All settings are reset to their default states defined by the current firmware.

## 9.4 Displaying Information on Hardware and Software

- Submenu item **Internal Statistics**

Shows basic general information about the hardware and the firmware. These may be relevant, for example, when contacting our technical support.

## 9.5 Browsing File Directories

- Submenu item **Browse Memory Card**

Display the contents of the file directories on the internal memory card to get an overview of the existing files.

## 9.6 Displaying Battery Status and Resetting Monitoring

➤ Submenu item **Battery Status**

The device contains 6 NiMH cells whose momentary voltages and temperatures are displayed in the graphics.

### **Battery Current**

Displays the momentary current flow of the batteries:

- └ Negative value: The batteries supply the device with the indicated current.
- └ Positive value: The batteries are charged by a connected power supply with the indicated current.

### **Accu Level**

Displays the momentary charge level of the batteries.

If the charge level of the batteries is no longer displayed plausibly (also in the status bar at the top), you can reset the charge level monitoring function with **Reset Charge Level**. Afterwards, fully charge the batteries once, best of all when the device is switched off.

### **Gas Gauge Temp.**

The monitoring module for the charge level of the batteries ("Gas Gauge" - level indicator) measures, among other things, the temperature in its environment, independently of the other temperature measurements on the batteries.

## 9.7 Calibrating the Termination Measurement

➤ Submenu item **Calibration CAN Termination**

In order to correctly determine values for the termination measurement (menu item **Measurements** > **CAN Termination**), the measuring unit must be calibrated. This is the case at delivery of the PCAN-Diag FD. On the screen for the measurement of the CAN termination, the date of the last calibration process is displayed.

If **No calib.** is displayed or if the measured values are not plausible, a calibration can be done here.

You need:

- 1 resistor 60 Ω, 0.1 %
- Self-made wiring for the connection of the resistor at the D-Sub connector between CAN-Low (pin 2) and CAN-High (pin 7), for example via a 9-pin D-Sub female connector.

The calibration procedure is described on the screen.

## 9.8 Managing Add-ins

If function extensions (add-ins) for the PCAN-Diag FD have been licensed by you, they can be managed here.

At the time of publishing this manual (2021-09-02), no add-ins are available yet.

# 10 Viewing Files

- Main menu item **View Files**

You can view specific files that are saved on the internal memory card directly with the PCAN-Diag FD:

- └ `*.bmp`:  
bitmaps, e.g. screenshots
- └ `*.txt, *.ini`:  
text files, e.g. reports

**M0:** in the directory structure stands for the internal memory card.

# 11 USB Connection

➤ Main menu item **USB Connection**

A USB connection to a PC is used for access to the internal memory card of the PCAN-Diag FD. The PC's operating system binds the memory card into the file management, e.g. under Windows as mass storage device.

Internal memory card	
Size	at least 2 GByte
File system	FAT32
Name of the USB device	PCAN-Diag FD

 **Note:** The memory card can be accessed only if the PCAN-Diag FD is switched on.

## 11.1 Automatic USB Connection

If **USB autoconnect** is enabled in the **Settings (On)**, the internal memory card is automatically connected to the PC. If the PCAN-Diag FD needs the memory card to save data or to access data, the USB connection is interrupted until the operation is finished.

 **Note:** If the option is enabled, the **USB Connection** entry is not available in the main menu.

## 11.2 Manual USB Connection

If **USB autoconnect** is disabled in the **Settings (Off)**, the internal memory card is connected to the PC with the main menu item **USB Connection**. When leaving the function, the internal memory card is disconnected again.

## 11.3 Purposes of the USB Connection

- Transferring projects onto the memory card of the PCAN-Diag with the provided Windows program PCAN-Diag FD Editor (8.1 on page 83)
- Accessing the traces, bit rate lists, bit rate frequencies, bitmaps, or CSV files created by the PCAN-Diag FD
- Storing an alternative splash screen in a project directory (8.2 on page 86)
- Placing a \*.bin file for a firmware update into the directory /PCAN-Diag FD/Firmware/
- Update of the provided tools for Windows and update of system files for the PCAN-Diag FD (11.4 below)
- Storage space at your disposal

## 11.4 Update of the Provided Tools for Windows

The internal memory card contains the software tools for preparing projects for the PCAN-Diag FD. These are regularly updated by PEAK-System and made available on our website: [www.peak-system.com/quick/DL-Packages-E](http://www.peak-system.com/quick/DL-Packages-E)

The download package for the PCAN-Diag FD contains all components that are also present on the internal memory card at delivery:

- └ manuals and additional information in PDF format
- └ firmware file
- └ device help
- └ Default project
- └ PCAN-Diag FD Editor for Windows
- └ PCAN-View for Windows
- └ PEAK-Converter for Windows

You can unpack the entire ZIP package or only required components into the corresponding folders on the internal memory card via a USB connection from the PC to the PCAN-Diag FD (overwrite existing files).

# 12 Technical specifications

<b>Supply</b>	
Supply voltage	12 V DC nominal, 9 ... 28 V possible
Rechargeable batteries	6 x AA NiMH 1.2 V 1900 mAh
Charging periods batteries	Charging station: about 2 h
	Power socket (device unoperated): about 4 h
	Power socket (device operated): about 11 h
Backup battery clock	Button cell CR1620 3.0 V
Current consumption	Quick-charge via charging station: 1.3 A
	Operation without charging (batteries full): 450 mA at 9 V 350 mA at 12 V 200 mA at 24 V
	Charging only (power socket): 580 mA at 9 V 450 mA at 12 V 260 mA at 24 V
	Operation with charging (batteries empty): 550 mA max. at 12 V

<b>D-Sub Connector</b>	
Function	CAN connection
Number of pins	9
Measurement	Voltage measurement $\pm 28$ V (10 bits resolution) at pins 6 and 9

<b>CAN</b>	
Transmission standards	CAN FD (ISO 11898-1 and Non-ISO), CAN 2.0 A/B
CAN bit rates	20 kbit/s ... 1 Mbit/s
CAN FD bit rates	20 kbit/s ... 12 Mbit/s
Transceiver	High-speed CAN ISO 11898-2 (MCP2558FD)
Termination	124 $\Omega$ between CAN-Low and CAN-High, switchable



### Trigger Output

Connector	Banana jack 4 mm
Voltage idle state	0 V
Voltage trigger event	about 3 V (rising edge)
Delay to the internal trigger	none

### Oscilloscope Function

Measuring channels	1: CAN-High 2: CAN-Low
Sampling frequency	100 MHz
Capacity sample buffer	1 MSample max.
Trigger types	CAN frame start/end, CAN ID, CAN error, bit rate switch; alternatively free-run mode
Pretrigger	10 %, 50 %, 90 %
Resolution amplitude	10 bit, 8 mV/digit
Measuring range amplitude	-1.5 ... +6.5 V
CAN-specific functions	Decoding of the recorded signal course
Data transfer	Screenshot of the current scope screen Contents of the sample buffer as CSV file

### Internal memory card

Size	4 GByte
File system	FAT32
Name of the USB device	PCAN-Diag FD

### USB port

Mechanics	USB socket type C
Max. transfer rate	USB 2.0 High-Speed
Function	Access to internal memory card

### Screen

Display type	TFT
Resolution	480 x 800 pixels
External output	Alternatively to internal display via Micro-HDMI socket, DVI signal, 800 x 600 pixels (4:3), 60 Hz

### Measures

Size	110 x 47 x 206 mm (W x H x D) See also dimension drawing Appendix B on page 100
Weight	680 g

### Environment

Operating temperature	on external supply with charging: 0 ... +40 °C (+32 ... +104 °F) on operation with batteries: 0 ... +50 °C (+32 ... +122 °F)
Temperature for storage and transport	-20 ... +50 °C (-4 ... +122 °F)
Relative humidity	15 ... 90 %, not condensing
Ingress protection (IEC 60529)	IP20

### Conformity

RoHS	EU directive 2011/65/EU (RoHS 2) EU directive 2015/863/EU (revised list of restricted substances) DIN EN IEC 63000:2019-05;VDE 0042-12:2019-05
EMC	EU directive 2014/30/EU DIN EN 61326-1:2013-07;VDE 0843-20-1:2013-07

# Appendix A CE Certificate

## EU Declaration of Conformity



This declaration applies to the following product:

Product name: **PCAN-Diag FD**  
Item number(s): **IPEH-003069/68**  
Manufacturer: **PEAK-System Technik GmbH**  
**Otto-Roehm-Strasse 69**  
**64293 Darmstadt**  
**Germany**

 We declare under our sole responsibility that the mentioned product is in conformity with the following directives and the affiliated harmonized standards:

**EU Directive 2011/65/EU (RoHS 2) + 2015/863/EU (amended list of restricted substances)**

**DIN EN IEC 63000:2019-05;VDE 0042-12:2019-05**

Technical documentation for the assessment of electrical and electronic products with respect to the restriction of hazardous substances (IEC 63000:2016); German version EN IEC 63000:2018

**EU Directive 2014/30/EU (Electromagnetic Compatibility)**

**DIN EN 61326-1:2013-07;VDE 0843-20-1:2013-07**

Electrical equipment for measurement, control and laboratory use - EMC requirements - Part 1: General requirements (IEC 61326-1:2012); German version EN 61326-1:2013

Darmstadt, 18 February 2021

A handwritten signature in black ink, appearing to read "Uwe Wilhelm".

Uwe Wilhelm, Managing Director

## Appendix B Dimension Drawing

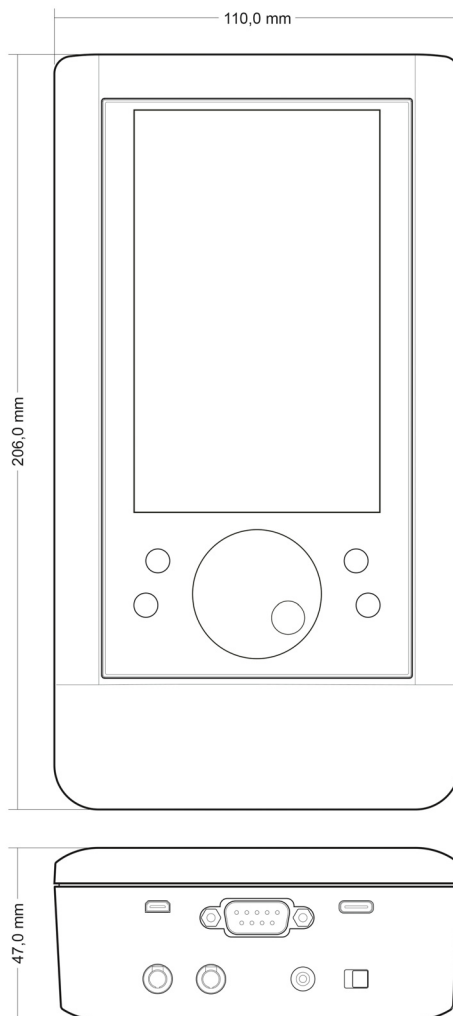

The figure does not show the original size.

## Appendix C Disposal Information (Batteries)

The device and the batteries it contains must not be disposed of with household waste. Remove the batteries from the unit for proper separate disposal.

The PCAN-Diag FD contains the following batteries:

- └ 1 x button cell CR1620 3.0 V
- └ 6 x AA 1.2 V NiMH

# Appendix D Changelog User Manual

This section lists the major changes in the User Manual releases (document version is listed).

## 1.2.0

- Changes in the device firmware 1.4.0:
  - a) Menu item **CAN Data > Transmit Messages** omitted, transmission functionality now completely in **CAN Data > Raw CAN Messages**.
  - b) Menu item **CAN Data > Trace Messages**: Busload is no longer available as recording option.
  - c) New: **CAN Data > Transmit Symbols**
  - d) Extended functionality by pressing medium-long or by pressing and holding the push dial in the symbolic display of CAN messages.
  - e) Busload measurement: optional graph for errors (blue) shows error frames/second instead of busload
  - f) DVI output signal using 800 x 600 pixels at 60 Hz
- Change in a previous version of the device firmware:
  - a) Calibration of the measurement function for CAN termination in the Support menu
- Scope of supply: video cable from Micro-HDMI to DVI
- Correction of the information on possible bit rates (nominal: 20 kbit/s ... 1 Mbit/s, data: 20 kbit/s ... 12 Mbit/s)